

JFE-700
Echo Sounder

**INSTRUCTION
MANUAL**

● Safety Cautions ●



Cautions for High Voltage

High voltages, ranging from several hundreds to tens of thousands of volts, are used in electronic apparatus, such as radio and radar instruments. These voltages are totally harmless in most operations. However, touching a component inside the unit is very dangerous. (Any person other than authorized service engineers should not maintain, inspect, or adjust the unit.) High voltages on the order of tens of thousand volts are most likely to cause instant deaths from electrical shocks. At times, even voltages on the order of several hundred volts could lead to electrocution. To defend against electrical shock hazards, don't put your hand into the inside of apparatus.

When you put in a hand unavoidably in case of urgent, it is strongly suggested to turn off the power switch and allow the capacitors, etc. to discharge with a wire having its one end positively grounded to remove residual charges. Before you put your hand into the inside of apparatus, make sure that internal parts are no longer charged. Extra protection is ensured by wearing dry cotton gloves at this time. Another important precaution to observe is to keep one hand in your pocket at a time, instead of using both hands at the same time. It is also important to select a secure footing to work on, as the secondary effects of electrical shock hazards can be more serious. In the event of electrical shocks, disinfect the burnt site completely and obtain medical care immediately.

Precautions for Rescue of Victim of Electric Shock

When a victim of electric shock is found, turn off the power source and ground the circuit immediately. If this is impossible, move the victim away from the unit as quick as possible without touching him or her with bare hands. He or she can safely be moved if an insulating material such as dry wood plate or cloth is used.

It is necessary to perform first aid immediately.

Breathing may stop if current flows through the respiration center of brain due to electric shock. If the electric shock is not large, breathing can be restored by artificial respiration. A victim of electric shock looks pale and his or her pulse may become very weak or stop, resulting in unconsciousness and rigidity at worst.

First Aid Method

Flow of Cardiopulmonary Resuscitation (CPR)

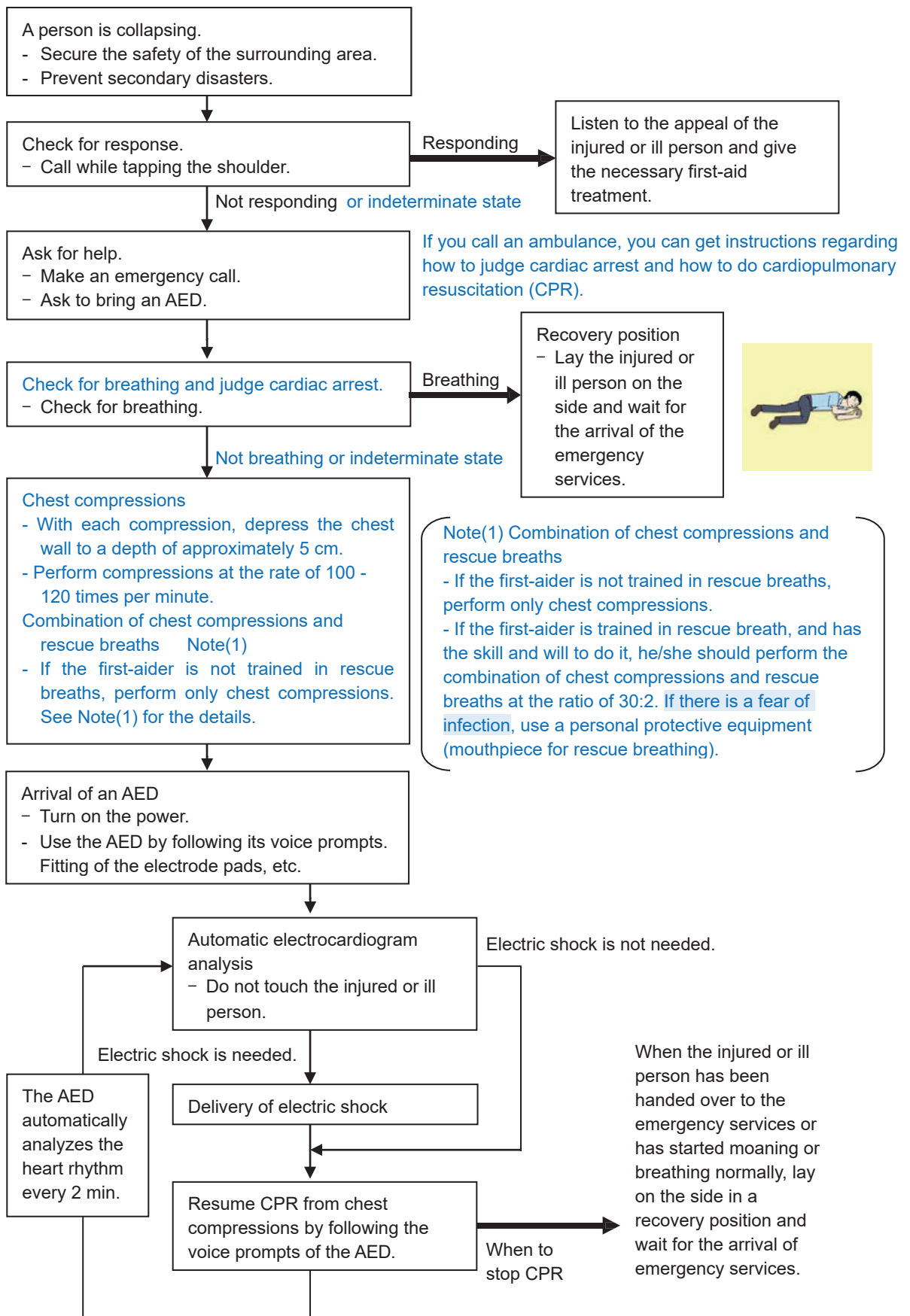

Specific Procedures for Cardiopulmonary Resuscitation (CPR)

1. Check the scene for safety to prevent secondary disasters

- a) Do not touch the injured or ill person in panic when an accident has occurred. (Doing so may cause electric shock to the first-aiders.)
- b) Do not panic and be sure to turn off the power. Then, gently move the injured or ill person to a safe place away from the electrical circuit.

2. Check for responsiveness

- a) Tap the shoulder of the injured or ill and shout in the ear saying, "Are you OK?"
- b) If the person opens eyes or there is some response or gesture, determine it as "responding." But, if there is no response or gesture, determine it as "not responding."



3. If responding

- a) Give first-aid treatment.

4. If not responding

- a) Ask for help loudly. Ask somebody to make an emergency call and bring an AED.
 - Somebody has collapsed. Please help.
 - Please call an ambulance.
 - Please bring an **AED**.
 - If there is nobody to help, call an ambulance yourself.

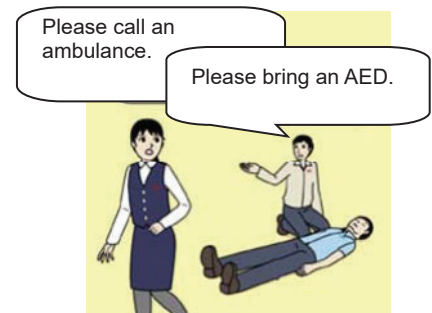

5. Check for breathing

- a) Look to see if the chest and abdomen of the injured or ill person are rising and falling.

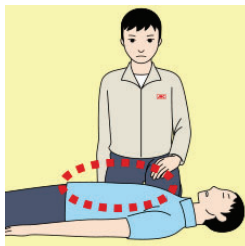

- b) If the injured or ill person is breathing, place the recovery position and wait for the arrival of the emergency services.
 - Position the injured or ill person on the side.

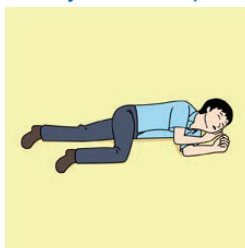

6. Cardiopulmonary resuscitation (CPR) (combination of chest compressions and rescue breaths)

a) Chest compressions

1) Position of chest compressions

- Position the heel of one hand in the center of the chest, approximately between the nipples, and place your other hand on top of the one that is in position.

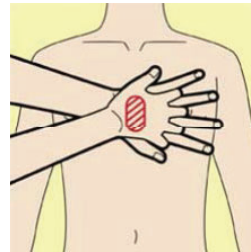
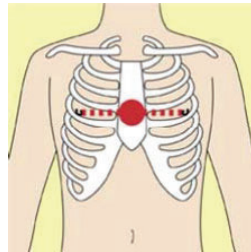

2) Perform chest compressions

Perform uninterrupted chest compressions of 30 at the rate of about 100 - 120 times per minute, **while** locking your elbows positioning yourself vertically above your hands.

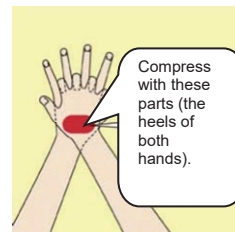

- With each compression, depress the chest wall to a depth of approximately 5 cm.

b) Combination of 30 chest compressions and 2 rescue breaths

- 1) If the first-aider is not trained in rescue breaths, he/she should perform only chest compressions.
- 2) If the first-aider is trained in rescue breath, and has the skill and will to do it, he/she should perform 30 chest compressions, then give 2 rescue breaths.
- 3) If there is a fear of infection, use a personal protective equipment (mouthpiece for rescue breathing).
- 4) Continuously perform the combination of 30 chest compressions and 2 rescue breaths without interruption.
- 5) If there are two or more first-aiders, alternate with each other approximately every two minutes (five cycles) without interruption.

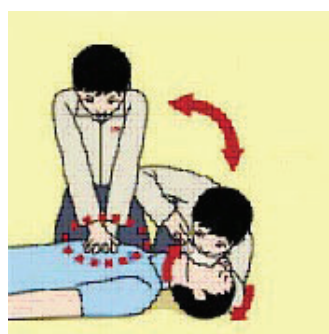

7. When to stop cardiopulmonary resuscitation (CPR)

- When the injured or ill person has been handed over to the emergency services
- When the injured or ill person has started moaning or breathing normally, lay on the side in a recovery position and wait for the arrival of emergency services.

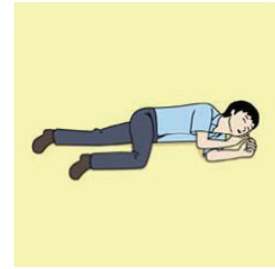

8. Arrival and preparation of an AED

- Place the AED at an easy-to-use position. If there are multiple first-aiders, continue CPR until the AED becomes ready.
- Turn on the power to the AED unit. Depending on the model of the AED, you may have to push the power on button, or the AED automatically turns on when you open the cover.
- Follow the voice prompts of the AED.

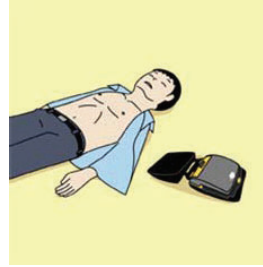

9. Attach the electrode pads to the injured or ill person's bare chest

- Remove all clothing from the chest, abdomen, and arms.
- Open the package of electrode pads, peel the pads off and securely place them on the chest of the injured or ill person, with the adhesive side facing the chest. If the pads are not securely attached to the chest, the AED may not function. Paste the pads exactly at the positions indicated on the pads. If the chest is wet with water, wipe dry with a dry towel and the like, and then paste the pads. If there is a pacemaker or implantable cardioverter defibrillator (ICD), paste the pads at least 3 cm away from them. If a medical patch or plaster is present, peel it off and then paste the pads. If the injured or ill person's chest hair is thick, paste the pads on the chest hair once, peel them off to remove the chest hair, and then paste new pads.
- Some AED models require to connect a connector by following voice prompts.
- The electrode pads for small children should not be used for children over the age of 8 and for adults.

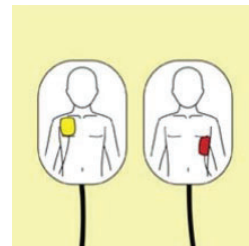

10. Electrocardiogram analysis

- The AED automatically analyzes electrocardiograms. Follow the voice prompts of the AED and ensure that nobody is touching the injured or ill person while you are operating the AED.
- On some AED models, you may need to push a button to analyze the heart rhythm.



11. Electric shock (defibrillation)

- a) If the AED determines that electric shock is needed, the voice prompt saying, "Shock is needed" is issued and charging starts automatically.
- b) When charging is completed, the voice prompt saying, "Press the shock button" is issued and the shock button flashes.
- c) The first-aider must get away from the injured or ill person, make sure that no one is touching, and then press the shock button.
- d) When electric shock is delivered, the body of the injured or ill person may jerk.



12. Resurgence of cardiopulmonary resuscitation (CPR)

- a) Resume chest compressions by following the voice prompts of the AED.
 - With each compression, depress the chest wall to a depth of approximately 5 cm.
 - Perform compressions at the rate of 100 - 120 times per minute.

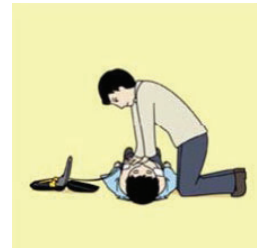

13. Automatic electrocardiogram analysis

- a) When 2 minutes have elapsed since you resumed cardiopulmonary resuscitation (CPR), the AED automatically analyzes the electrocardiogram.
- b) If you suspended CPR by following voice prompts and AED voice prompt informs you that shock is needed, give electric shock again by following the voice prompts.
If AED voice prompt informs you that no shock is needed, immediately resume CPR.

14. When to stop CPR (Keep the electrode pads on.)

- a) When the injured or ill person has been handed over to the emergency services
- b) When the injured or ill person has started moaning or breathing normally, lay on the side in a recovery position and wait for the arrival of emergency services.

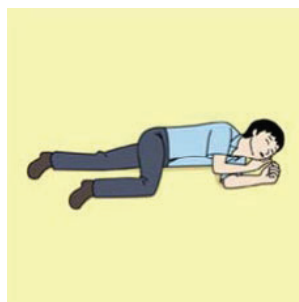

General Information

Thank you for purchasing the JFE-700 Echo-Sounder manufactured by Japan Radio Co., Ltd. The JFE-700 conforms to the IMO (International Maritime Organization) performance standards, enabling seabed displays and digital depth displays.

Please read this instruction manual before attempting to operate this equipment.

You are strongly recommended to store this instruction manual carefully for future reference. In the event that you have an operational problem or malfunction, this manual will provide useful instructions.

Before You Begin

Symbols Used in This Manual

To ensure that the equipment is used safely and correctly, and that the operator and third parties are not exposed to danger or damage, various pictograms are used in this manual and on the equipment itself. These pictograms are described below.

Please familiarize yourself with these pictograms and the meanings they convey before reading the rest of the manual.



DANGER

Failure to observe a danger indication, leading to incorrect handling, may result in an imminent risk of death or serious injury.



WARNING

Failure to observe a warning indication, leading to incorrect handling, may result in death or serious injury to the operator.



CAUTION

Failure to observe a caution indication, leading to incorrect handling, may result in injury to the operator, or physical damage to the equipment.

Example Pictograms



This mark is intended to alert the user to the presence of precautions including danger and warning items. The picture in each mark alerts you to operations that should be carefully performed.



This mark is intended to alert the user to the presence of prohibited activity. The picture/word in/beside each mark alerts you to operations that are prohibited.



This mark is intended to alert the user to the presence of necessary instructions. The picture in each mark alerts you to operations that must be performed.

Warning Labels



There is a warning label on the top of NJA-710 display processing unit.

Do not try to remove, break or modify the label.

Usage Hints

DANGER



Do not remove the cover of this set. Otherwise, you may touch a high-voltage part and suffer from an electrical shock.

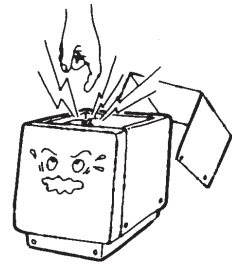

Do not dismantle or modify this equipment. Failure to observe this warning may result in fire, electric shock, or damage.

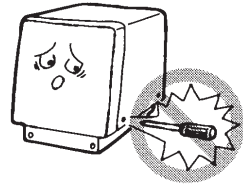

Do not insert or remove the power cord or operate switches with a wet hand. Otherwise, you may suffer from an electrical shock.

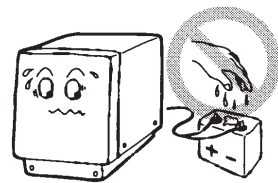



WARNING



Do not damage, break or modify the power cord.
When a heavy object is placed on the cord or the cord is heated, pulled, or forcibly bent, the cord will be broken resulting in a fire or an electrical shock.

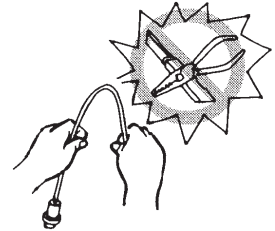

Do not place any vessels containing water or other liquids, or metal objects, on top of this equipment. If water is spilled on or metal objects fall into the equipment there is a risk of fire, electric shock, or damage.

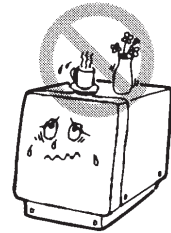

Do not use this set at a voltage other than the supply voltage stated on the set.
Otherwise, a fire, an electrical shock, or a failure may occur.

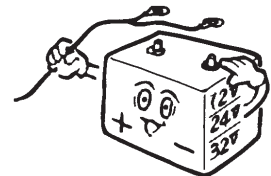

In the event of water or metal objects falling inside the equipment, immediately turn off the power switch, then contact JRC or its agent.
There is a risk of fire or electric shock if you continue to use the equipment.

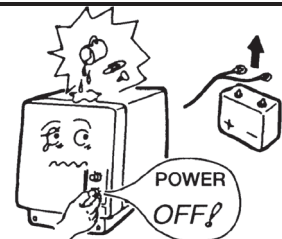

If you notice smoke, unusual smells, or abnormal heat coming from the equipment, immediately turn off the power switch, then contact JRC or its agent.
There is a risk of fire, electric shock, or damage if you continue to use the equipment.

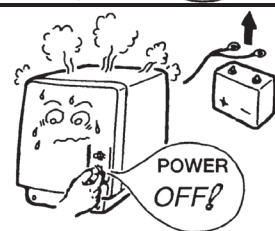

There are no customer-serviceable parts inside. Unauthorized inspections and repairs could cause fires and electrical shock hazards.



Please call our field representative or your nearest JRC office for inspection and repair services.



Use only the specified fuses.
The use of other fuse may cause fire and/or damage.
The Main switch on the CQD-2348 I/F unit must be turned off during replacing a fuse.

CAUTION



Please contact JRC or its agent for the electrical installation of this equipment. Electrical installations carried out by other than the qualified staff may result in faulty operation.



Do not store or operate the equipment where subject to temperatures more than 55°C or less than -15°C. High temperature may cause failures.

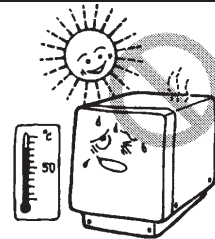

Do not install the equipment on unstable or unlevelled surfaces. Failure to observe this condition may result in the equipment falling or toppling over, resulting in injury.

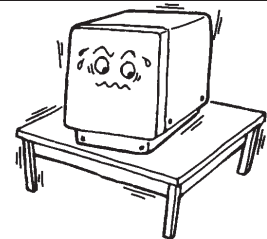

If it is cold, do not move the display equipment suddenly into a warm environment and switch it on. High-voltage leaks due to condensation may result in damage to the equipment.

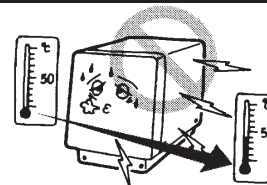

When condensation forms, leave the equipment in the warm environment for about 30 minutes before switching it on.



When installing the equipment, securely connect the earth lead to the earth terminal. Failure to connect the earth may result in electric shock in the event of a fault or power leak developing.

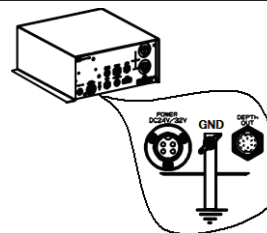

Use the echo sounder only as a navigation aid. Making the final navigation decision based only on the echo sounder display information may cause accidents such as collisions or running aground.



Use a chart to secure a safe depth when the equipment cannot measuring depth by malfunction, and contact JRC or our distributor for repair.

CAUTION



Do not turn on the equipment's power when the ship is in dry docks.
Failure to observe this caution may result in damage to the transducer, etc. by heat.



When removing the power cord, be sure to remove the power cord terminal correctly.
If the power cord is pulled, the cord may be damaged resulting in a fire or an electrical shock.

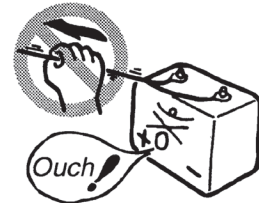

Do not install the units on the place being poor ventilation.
Otherwise, the set that is heated may cause a fire or failure.

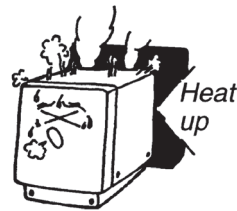

For safety when the equipment is to be left unused for an extended period, turn off the power switch.

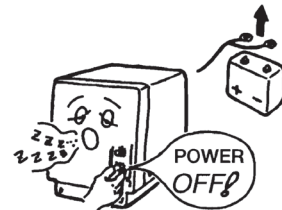

Take care when laying the transducer cable, power cable, and earth lead as positioning has an affect on electromagnetic interference. There is a risk of interfering with other equipment or the echo-sounder being interfered with by the other equipment.



After installing the echo-sounder, turn on the power to all other equipment to check for interference with or from all the equipment. Interference may cause malfunctions.



Handle the paper cutter of printer carefully not to cut your hand.

External View of JFE-700 Echo Sounder



NJA-710 Display processing unit

Explanation of Terms

Bubbling: The phenomenon where the image of the seabed is interrupted due to air bubbles caused by the ship's hull or the propeller during a voyage.

CAM: Central Alert Management

IMO: abbreviation for the International Maritime Organization.

MED: abbreviation for the Marine Equipment Directive. This is the directive for marine equipment in Europe. This directive unifies format approval standards implemented separately by each European.

NMEA0183: formats for the National Marine Electronics Association. NMEA0183 is the format used when sending or receiving depth, position, water temperature, ship speed and other information between marine equipment.

STC: Sensitivity Time Control is used for reduce shallow water clutter. Shallow seabed echo is strong and deep seabed echo is weak. So, the STC controls the sensitivity to normalize seabed echo for precision seabed tracking.

Transducer: Device that emits ultrasonic waves in water and receives the signals reflected off the seabed. This is equivalent to an antenna on a radio.

UTC: abbreviation for the Universal Time Coordinated.

Contents

● Safety Cautions ●	i
First Aid Method	ii
General Information	vii
Before You Begin	viii
Usage Hints	ix
External View of JFE-700 Echo Sounder	xiii
Explanation of Terms	xiv
1. Introduction	1-1
1.1 Function	1-1
1.2 Feature	1-1
1.3 Components	1-2
1.4 Construction	1-4
1.5 System Configuration	1-10
1.6 Interconnection Diagram	1-11
2. Control Panel	2-1
3. Display mode	3-1
3.1 Standard mode	3-1
3.2 History mode	3-2
3.3 Docking mode	3-3
4. Operation	4-1
4.1 Basic Operation	4-1
Turning Power ON/OFF	4-1
Adjusting Control Panel Illumination [DIM+/DIM-]	4-1
Range Control [RANGE]	4-1
Gain control [GAIN]	4-2
Selecting Display Mode [MODE]	4-3
Draft control [DRAFT]	4-3
Displaying Menu [MENU]	4-4
Up and Down Key Cursor [CURSOR]	4-4
Right and Left Key of Cursor [CURSOR]	4-5
4.2 Menu List	4-6
Menu Tree	4-6
4.3 Display Setting	4-7
Selecting Image Scrolling Speed	4-7
Noise Rejection	4-8
Interference Rejection	4-8
Setting Cursor Display	4-9
Display setting of sea bottom line	4-9
Setting Depth Display	4-10
Switching the display colors of the day and night screen	4-11
Switching latitude and longitude display	4-11
4.4 Setting Depth Alert	4-12
4.5 Initial Setting	4-13
Change screen color	4-13
Setting Adjustment of Date and Time	4-15
Touch Panel Calibration	4-17
4.6 Printer Control Setting	4-18
Setting Print Mode	4-18

Setting Log Book Print.....	4-21
Setting Log graphical printout Length	4-21
4.7 Checking system version	4-22
4.8 Initializing menu settings	4-22
4.9 Print out menu.....	4-23
4.10 SELF TEST	4-23
Demo Mode	4-24
Self-test of Control Unit	4-24
Self-test of LCD Unit.....	4-25
Self-test of Touch Panel.....	4-25
Self-test of Printer.....	4-25
Self-test of Alert	4-26
Self-test of Buzzer Test.....	4-30
Self-test of TRANSDUCER.....	4-31
4.11 Displaying of EQUIP menu	4-32
4.12 Alert Control	4-33
Over view	4-33
List of generating alert	4-33
Alert icon and status	4-34
Alert Display	4-35
Alert List function	4-36
Alert History	4-36
Connecting with CAM system.....	4-37
Time variation of Alert.....	4-37
5. Maintenance & Check.....	5-1
5.1 Daily Maintenance.....	5-1
5.2 Maintenance and check method	5-1
5.3 Maintenance Function.....	5-2
5.4 Replacing Printer Paper	5-2
5.5 Troubleshooting.....	5-3
5.6 Replacing Fuses	5-4
5.7 Repair Parts	5-4
5.8 Regular replacement parts	5-4
6. Consider Installation	6-1
7. After-sales Service.....	7-1
7.1 When Requesting Servicing.....	7-1
7.2 Recommendations for Inspection and Maintenance	7-1
7.3 Warranty & After-sales Service	7-2
8. Disposal.....	8-1
8.1 Disposal of this equipment.....	8-1
8.2 Chinese Version RoHS	8-1
9. Specifications.....	9-1
10. Appendix.....	10-1
10.1 Echo sample.....	10-1
10.2 Data Format.....	10-5

1. Introduction

1.1 Function

The JFE-700 Echo-Sounder consists of a transducer mounted on the bottom of the ship's hull and a main unit that displays information on the depth and formation of the seabed. This information is gained by using ultrasonic waves sent from the transducer that are then reflected off the sea bottom and picked up again by the transducer. The JFE-700 also has the following functions:

(1) depth alert, (2) power fail alert, (3) output of depth data, (4) output of depth and power fail alerts.

1.2 Feature

The JFE-700 features the following:

- Three display modes; standard, history, and docking.
- Depth data for last 48 hours in memory to play back the past sounding information.
- Dual frequency mode and two transducers are available in option. (*requires an optional equipment)

Conforms to the IMO Performance Standard

- When the depth becomes shallower than a previously set value, a depth alert is issued by buzzer and LCD display.
- When power is cut to the main unit, a power fail alert is issued by buzzer and LCD display.
- Contact signals can be output for both depth and power fail alerts.
- Data on depths can be output.

Digital Depth Display

- No need for time-consuming reading of depths using a scale against the profile of the seabed on the paper. The current depth can be seen at a glance.
- The viewing distance of display is 1.8m or less.

Self-Diagnostic Functions

- Self-diagnostic functions can be selected from a menu, improving ease of maintenance.

1.3 Components

This section lists the components.

Standard Equipment

Name	Type No.	Qty.	Remarks
Display Processing unit	NJA-710	1	
Matching box (primary)	NQD-2597	1	200kHz
	NQD-2598		50kHz
Transducer (primary)	NKF-349	1	200kHz (with cable 20,30,40,50m)
	NKF-350		50kHz (with cable 20,30,40m)
Spare parts	7ZXNA2009	1	Fuse × 2, Printer paper × 1
Instruction manual	7ZPNA2081	1	

Option

Name	Type No.	Remarks
Matching box	NQD-2597	200kHz
	NQD-2598	50kHz
	AW-154F	200kHz
	AW-154F-50	50kHz
Transducer	NKF-349	200kHz (with cable 20,30,40,50m)
	NKF-350	50kHz (with cable 20,30,40m)
	NKF-341	200kHz (with cable 20,30,40,50m)
	NKF-345	50kHz (with cable 20,30,40m)
Gate valve transducer	NKF-394	200kHz (with cable 20,30,40,50m)
	NKF-396	200kHz (with cable 20,30,40m)
	G-002759	Alphatron Gate valve for 200kHz LR
	G-002758	Alphatron Gate valve for 50kHz LR
	G-002760	Alphatron Gate valve for 200kHz ABS
	G-002761	Alphatron Gate valve for 50kHz ABS
	G-002762	Alphatron Gate valve for 200kHz BV
	G-002763	Alphatron Gate valve for 50kHz BV
	G-008792	Alphatron Gate valve for 200kHz DNV
	G-008791	Alphatron Gate valve for 50kHz DNV
Spare parts	7ZXNA2010	Fuse × 2, Printer paper × 4
	7ZXNA2011	Fuse × 2, Printer paper × 10
Junction Box	JB-340	for junction
Output buffer	NQA-4351	12ch buffer unit
Remote display	NWZ-4610	Remote display for Depth data
Dimmer unit	NCM-227	for remote display
AC power rectifier	NBA-5143	for remote display
Conversion flange for JFE-680	BRBX05692	Flush mounting Kit

Regarding model number

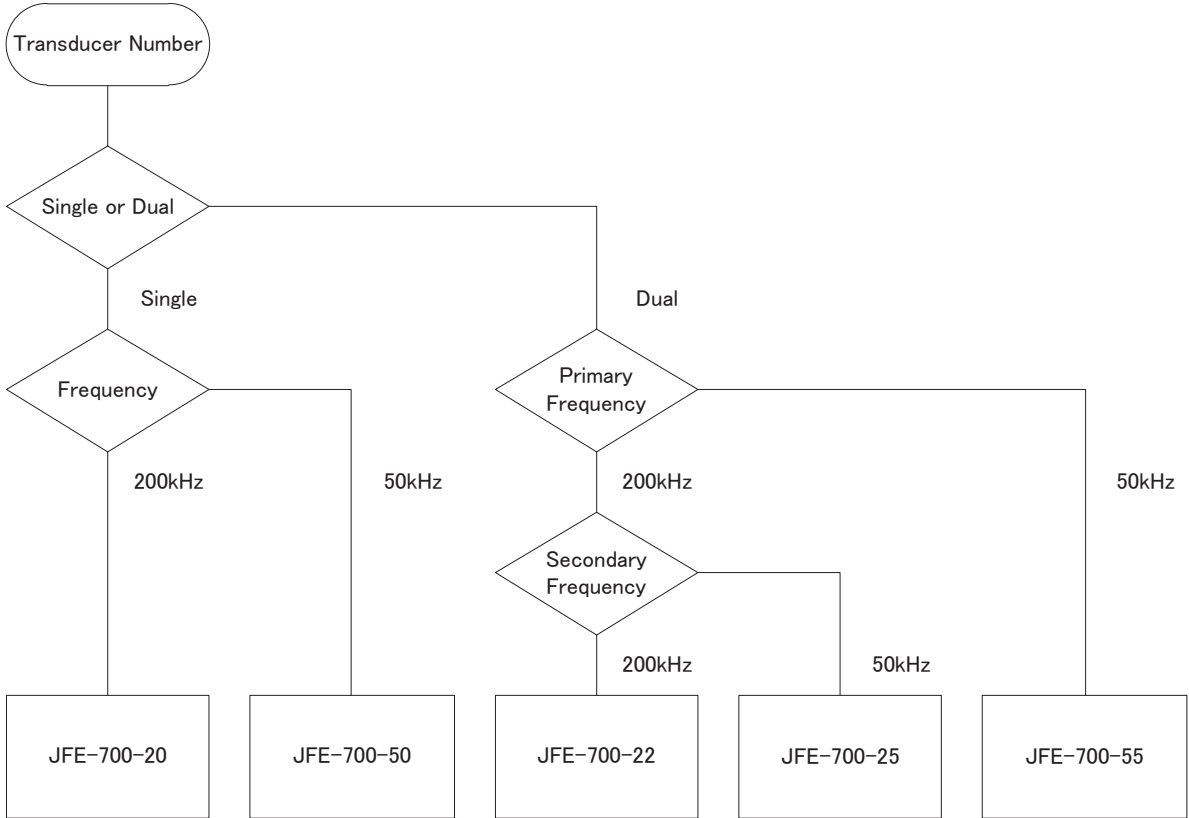

1.4 Construction

Equipment Outline

The following shows the external dimensions of the JFE-700.

External Dimension of NJA-710 Display Processing Unit

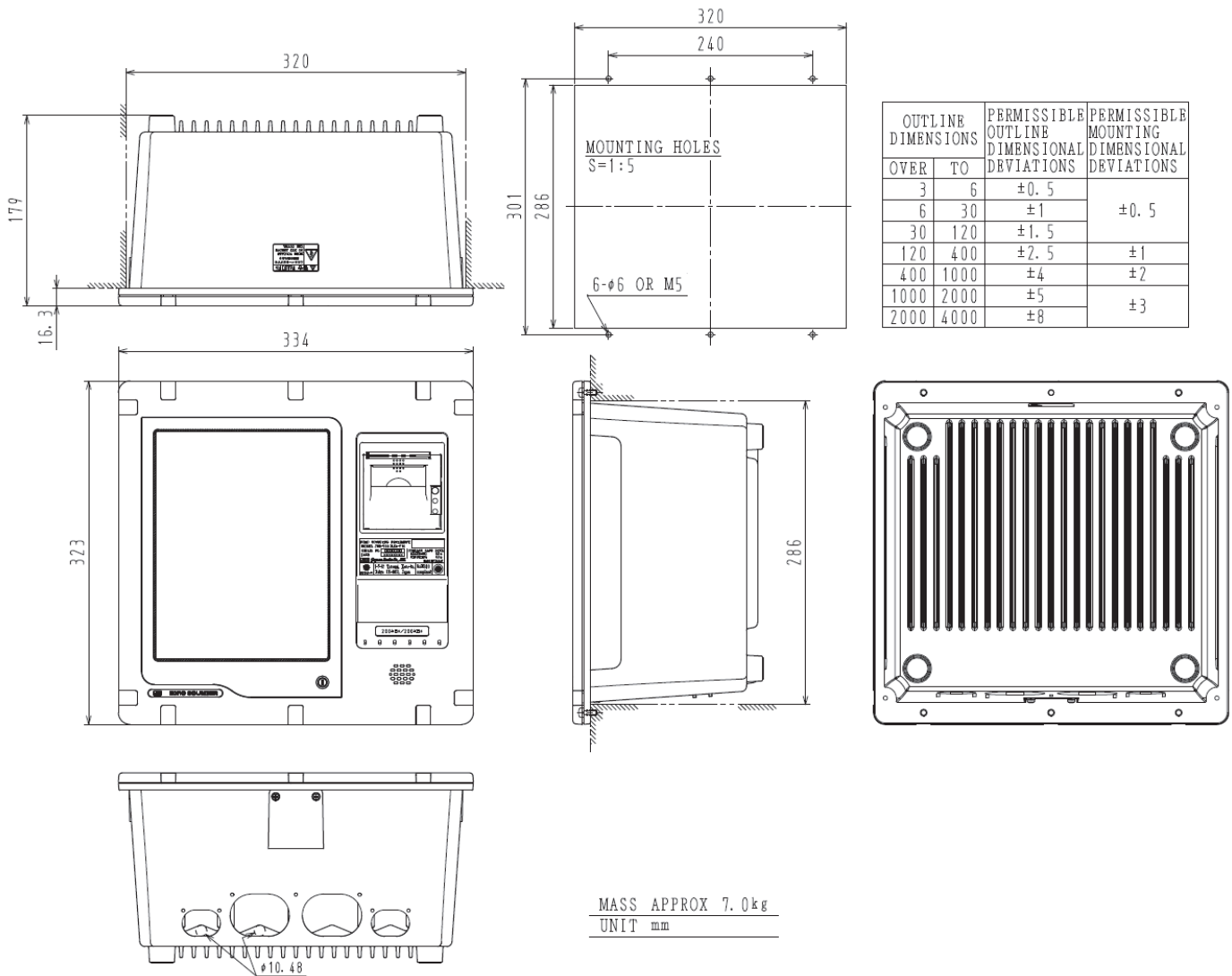

External Dimension of NQD-2597 Matching Box for 200kHz

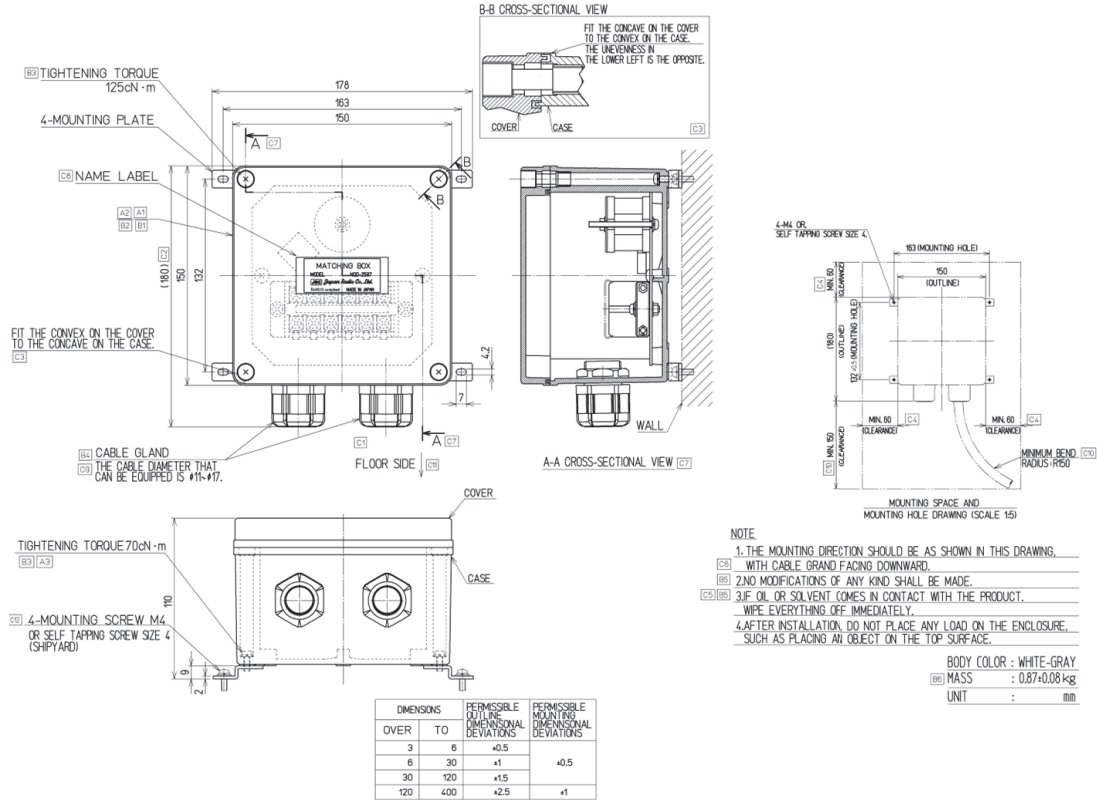

External Dimension of NQD-2598 Matching Box for 50kHz

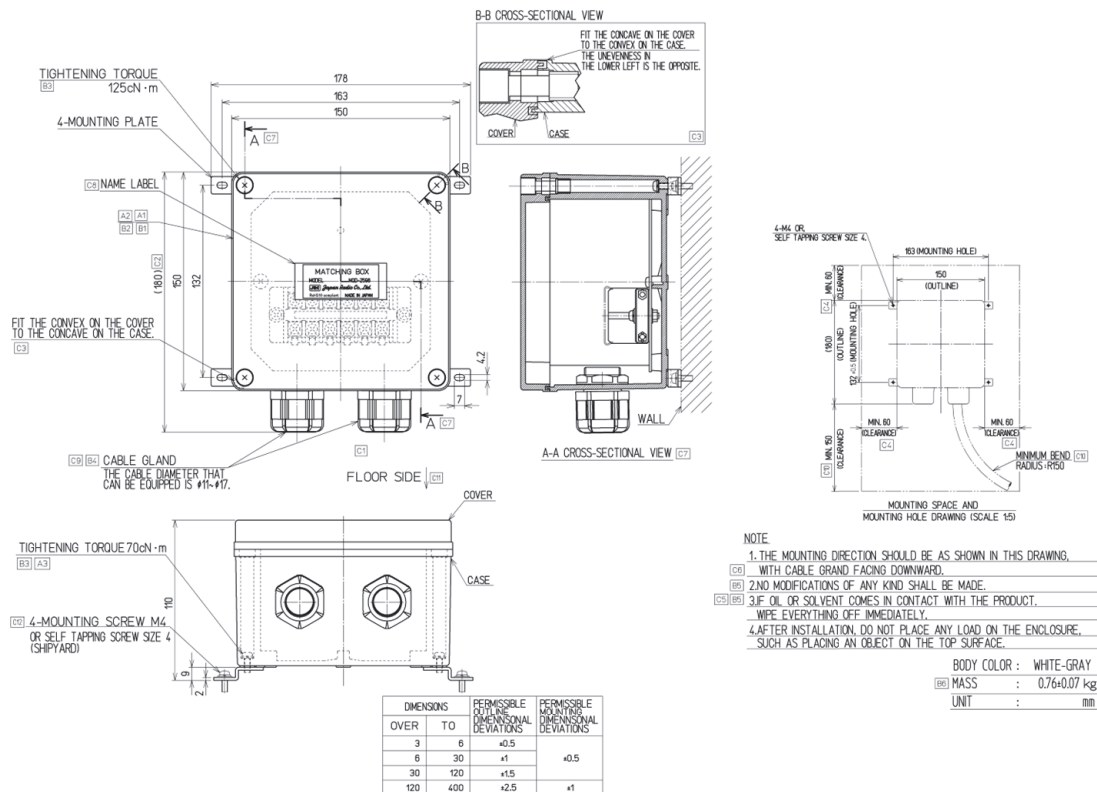

External Dimensions of Transducer

The external dimensions illustrated below are for the standard equipment. Please refer to the separately supplied drawings if your specifications are not standard.

External Dimension of NKF-349 Transducer

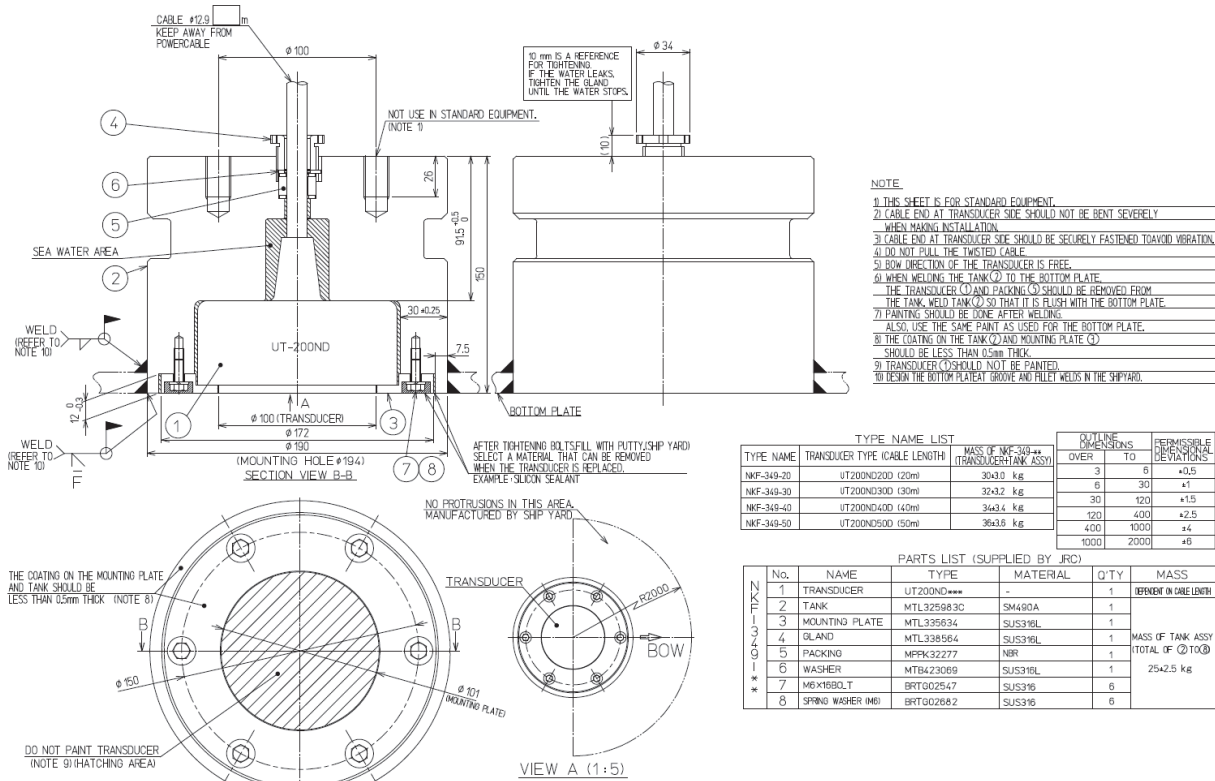

NKF-349 STANDARD EQUIPMENT

External Dimension of NKF-350 Transducer

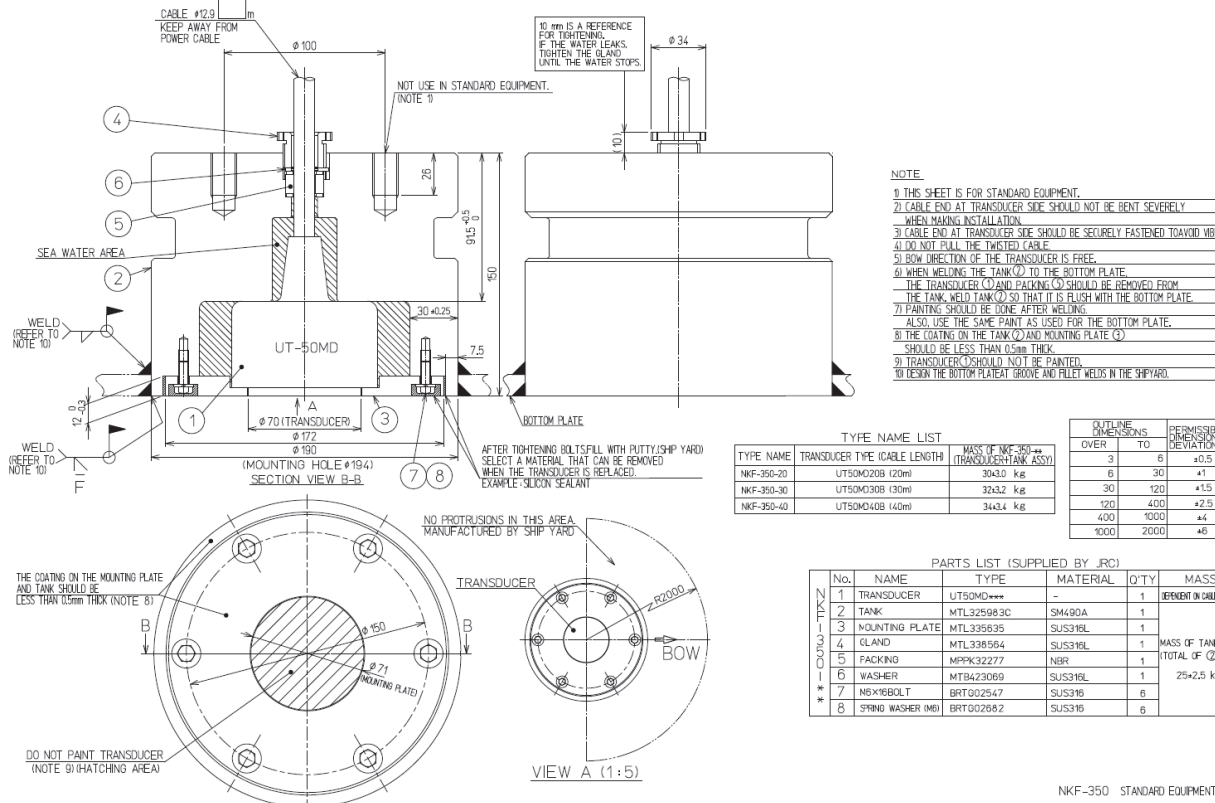

NKF-350 STANDARD EQUIPMENT

1. Introduction

External Dimension of NKF-341 Previous Transducer (Previous Model)

OUTLINE DIMENSIONS OVER	TO	PERMISSIBLE DIMENSIONAL DEVIATIONS
3	6	±0.5
6	30	±1
30	120	±1.5
120	400	±2.5
400	1000	±4
1000	2000	±6
2000	4000	±8

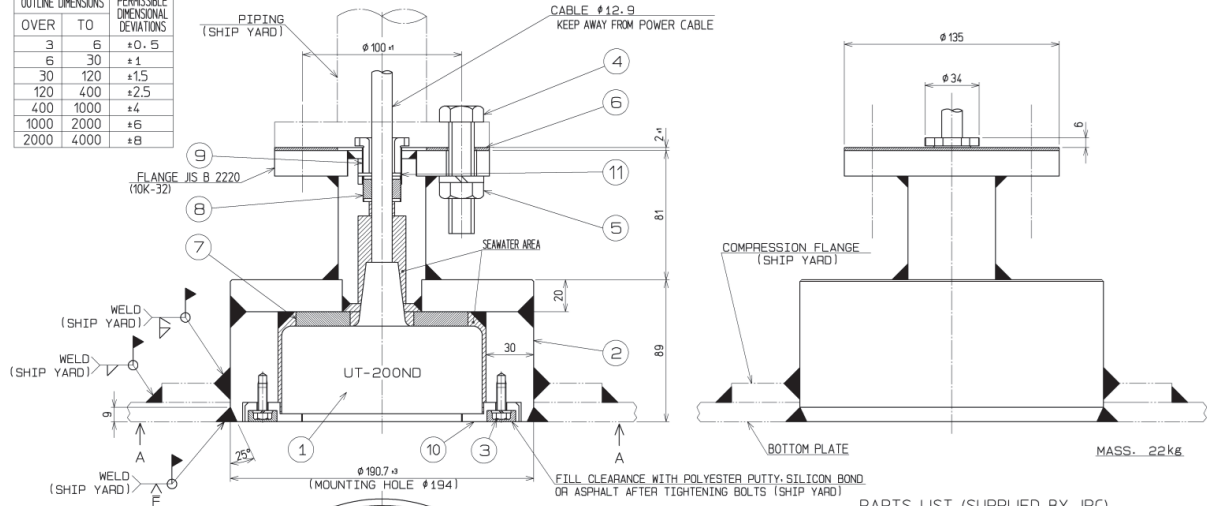

- NOTE
- BOW DIRECTION OF THE TRANSDUCER IS FREE.
 - WELDING THE TANK (2) TO THE BOTTOM PLATE, THE TRANSDUCER (1), THE PACKING (6) AND THE SPACER (7) SHOULD BE REMOVED FROM THE TANK. AFTER WELDING, SHOULD BE PAINTED IN THE SAME WAY TO THE BOTTOM PLATE.
 - THE MOUNTING PLATE (10) SHOULD BE PAINTED IN THE SAME WAY TO THE BOTTOM PLATE.
 - THE TANK AND THE MOUNTING PLATE ARE FINISHED BY SHOP PRIMER.
 - THE WELDING GROOVE OF THE BOTTOM PLATE AND THE COMPRESSION FLANGE ARE DESIGNED IN THE SHIPYARD ACCORDING TO THE CLASSIFICATION.

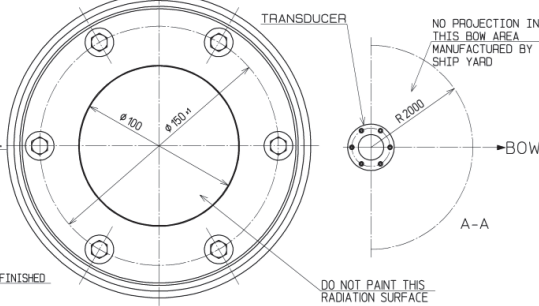

PARTS LIST (SUPPLIED BY JRC)

NO	NAME	TYPE	MATERIAL	Q'TY
1	TRANSDUCER	UT-200ND		1
2	TANK with FLANGE		KSTPT42 (C≦0.23%)	1
3	M6X16 BOLT		SUS304B	6
4	M16X70 BOLT		SS400	4
5	M16 NUT		SUS304B	4
6	PACKING	MTT004170A	JOINT SHEET	1
7	SPACER	MTT015293	RUBBER	1
8	PACKING	MPPK00784	RUBBER	1
9	GLAND	MTL024005	SUS304B	1
10	MOUNTING PLATE	MTL024129	SS400	1
11	WASHER	MTD003720	SPCC	1

External Dimension of NKF-345 Transducer (Previous Model)

OUTLINE DIMENSIONS OVER	TO	PERMISSIBLE DIMENSIONAL DEVIATIONS
3	6	±0.5
6	30	±1
30	120	±1.5
120	400	±2.5
400	1000	±4
1000	2000	±6
2000	4000	±8

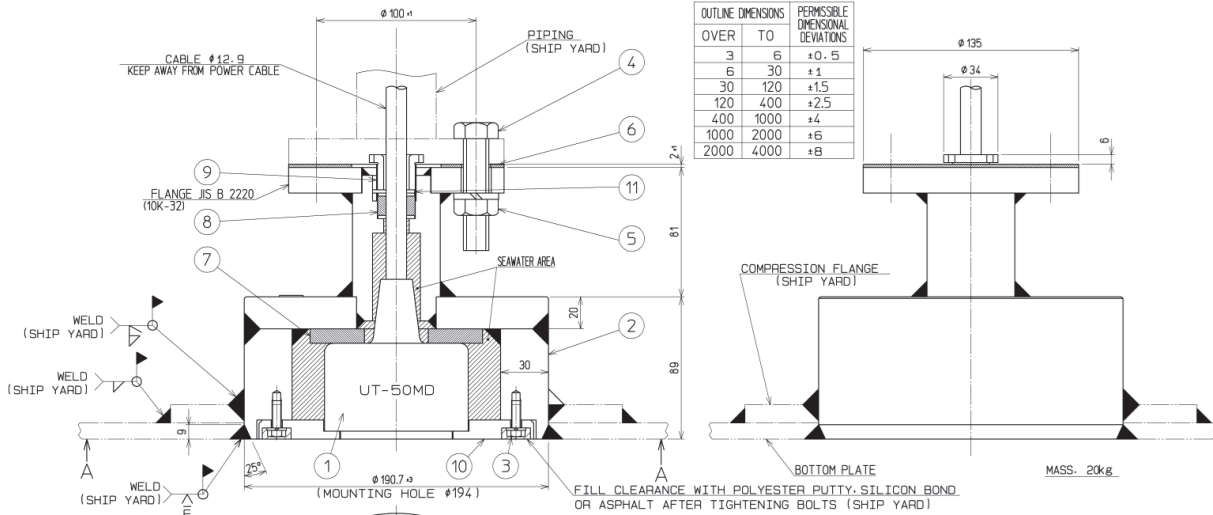

- NOTE
- BOW DIRECTION OF THE TRANSDUCER IS FREE.
 - WELDING THE TANK (2) TO THE BOTTOM PLATE, THE TRANSDUCER (1), THE PACKING (6) AND THE SPACER (7) SHOULD BE REMOVED FROM THE TANK. AFTER WELDING, SHOULD BE PAINTED IN THE SAME WAY TO THE BOTTOM PLATE.
 - THE MOUNTING PLATE (10) SHOULD BE PAINTED IN THE SAME WAY TO THE BOTTOM PLATE.
 - THE TANK AND THE MOUNTING PLATE ARE FINISHED BY SHOP PRIMER.
 - THE WELDING GROOVE OF THE BOTTOM PLATE AND THE COMPRESSION FLANGE ARE DESIGNED IN THE SHIPYARD ACCORDING TO THE CLASSIFICATION.

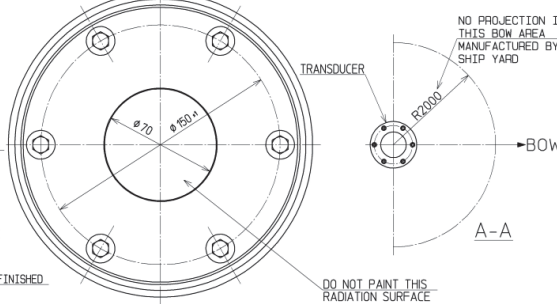

PARTS LIST (SUPPLIED BY JRC)

NO	NAME	TYPE	MATERIAL	Q'TY
1	TRANSDUCER	UT-50MD		1
2	TANK with FLANGE		KSTPT42 (C≦0.23%)	1
3	M6X16 BOLT		SUS304B	6
4	M16X70 BOLT		SS400	4
5	M16 NUT		SUS304B	4
6	PACKING	MTT004170A	JOINT SHEET	1
7	SPACER	MTT015293	RUBBER	1
8	PACKING	MPPK00784	RUBBER	1
9	GLAND	MTL024005	SUS304B	1
10	MOUNTING PLATE	MTL024128A	SS400	1
11	WASHER	MTD003720	SPCC	1

External Dimension of NKF-394 Gate valve Transducer

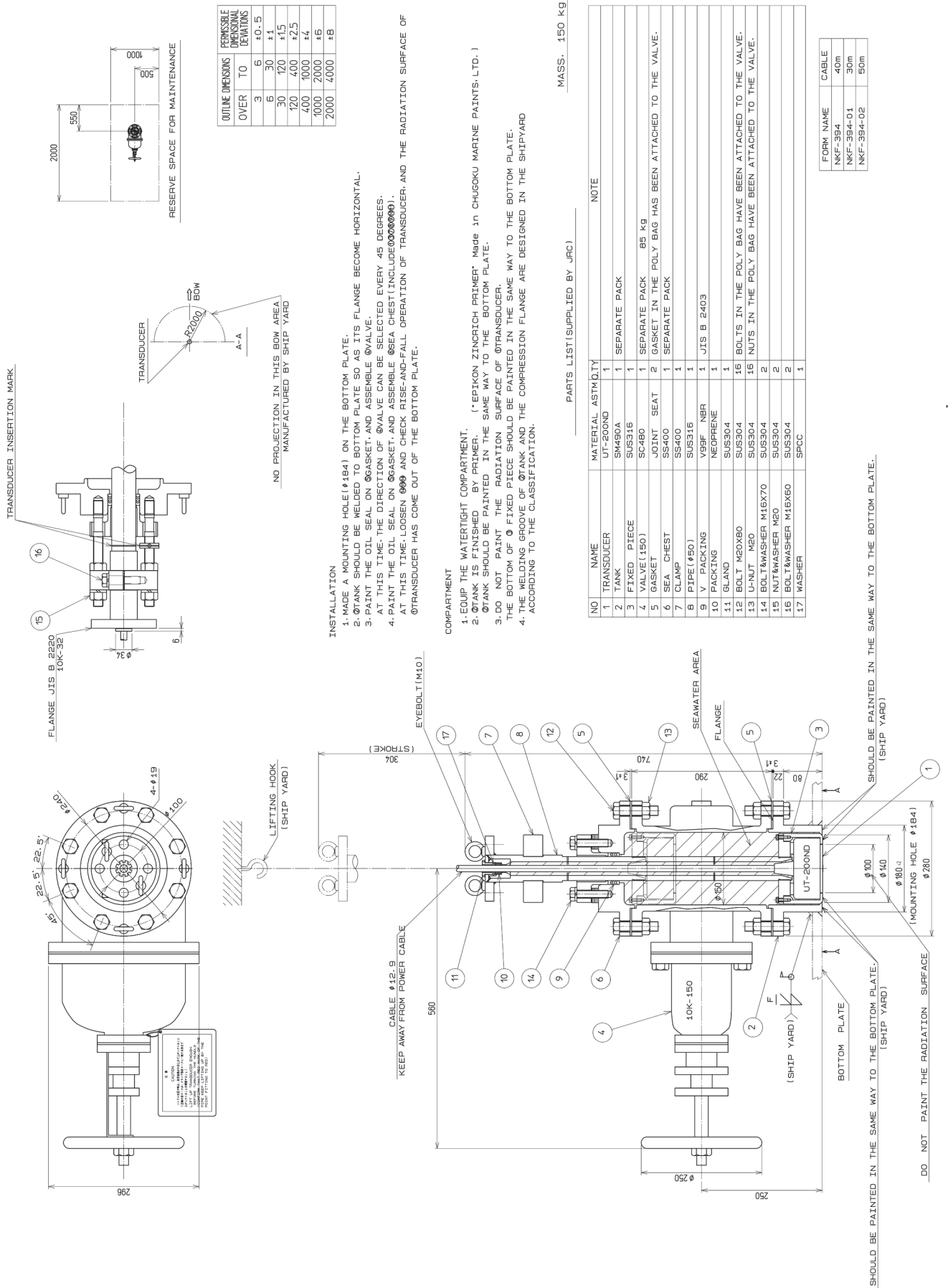

External Dimension of NKF-396 Gate valve Transducer

OUTLINE DIMENSIONS		PERMISSIBLE DIMENSIONAL DEVIATIONS
OVER	TO	
3	6	+0.5
6	30	+1
30	120	+1.5
120	400	+2.5
400	1000	+4
1000	2000	+6
2000	4000	+8

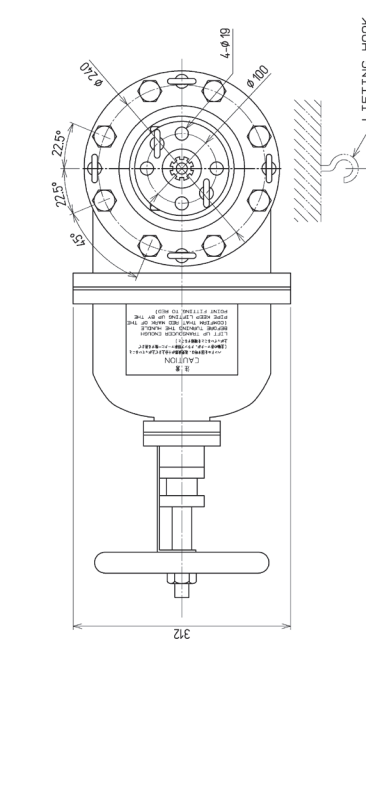
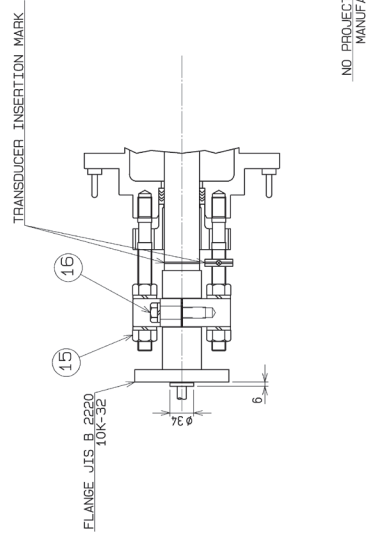

NO. PROJECTION IN THIS BOW AREA MANUFACTURED BY SHIP YARD

TRANSUCER

R2000

BOW

A-A

INSTALLATION

1. MADE A MOUNTING HOLE (#184) ON THE BOTTOM PLATE.
2. TANK SHOULD BE WELDED TO BOTTOM PLATE SO AS ITS FLANGE BECOME HORIZONTAL.
3. PAINT THE OIL SEAL ON 5 GASKET, AND ASSEMBLE 4 VALVE.
4. AT THIS TIME, THE DIRECTION OF 4 VALVE CAN BE SELECTED EVERY 45 DEGREES.
5. PAINT THE OIL SEAL ON 5 GASKET, AND ASSEMBLE 6 SEA CHEST (INCLUDE 13, 7, 8, 9, 10, 11).
6. AT THIS TIME, LOOSEN 14, 15 AND CHECK RISE-AND-FALL OPERATION OF TRANSDUCER, AND THE RADIATION SURFACE OF 1 TRANSDUCER HAS COME OUT OF THE BOTTOM PLATE.

COMPARTMENT

1. EQUIP THE WATERTIGHT COMPARTMENT.
2. TANK IS FINISHED BY PRIMER. (*EPIKON ZINCRICH PRIMER* Made in CHUGOKU MARINE PAINTS, LTD.)
3. TANK SHOULD BE PAINTED IN THE SAME WAY TO THE BOTTOM PLATE.
4. DO NOT PAINT THE RADIATION SURFACE OF 1 TRANSDUCER.
5. THE BOTTOM OF 3 FIXED PIECE SHOULD BE PAINTED IN THE SAME WAY TO THE BOTTOM PLATE.
6. THE WELDING GROOVE OF 2 TANK AND THE COMPRESSION FLANGE ARE DESIGNED IN THE SHIPYARD ACCORDING TO THE CLASSIFICATION.

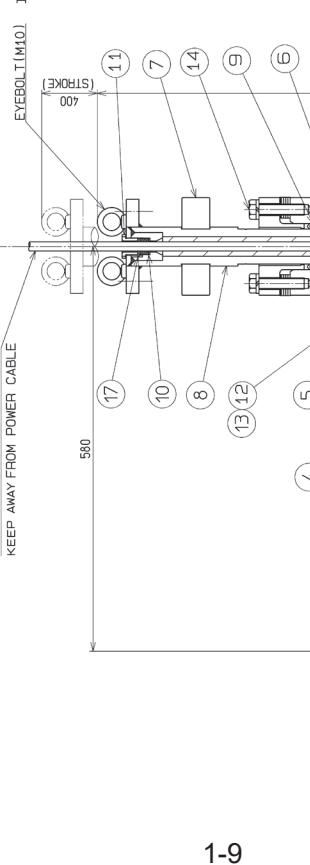

MASS. 150kg

PARTS LIST (SUPPLIED BY JRC)

NO	NAME	MATERIAL	ASTM	QTY	NOTE
1	TRANSDUCER	UT-50MD		1	
2	TANK	SM450A		1	SEPARATE PACK
3	FIXED PIECE	STRM13A		1	
4	VALVE (150)	SC480		1	SEPARATE PACK 85kg
5	GASKET	JOINT SEAT		2	GASKET IN THE POLY BAG HAS BEEN ATTACHED TO THE VALVE.
6	SEA CHEST	SS400		1	SEPARATE PACK
7	CLAMP	SS400		1	
8	PIPE (φ50)	SUS304		1	
9	V PACKING	V99F NBR		1	JIS B 2403
10	PACKING	NEOPRENE		1	
11	GLAND	SUS304		1	
12	BOLT M20X80	SUS304		16	BOLTS IN THE POLY BAG HAVE BEEN ATTACHED TO THE VALVE.
13	U-NUT M20	SUS304		16	NUTS IN THE POLY BAG HAVE BEEN ATTACHED TO THE VALVE.
14	BOLT & WASHER M16X70	SUS304		2	
15	NUT & WASHER M20	SUS304		2	
16	BOLT & WASHER M16X60	SUS304		2	
17	WASHER	SPCC		1	

SHOULD BE PAINTED IN THE SAME WAY TO THE BOTTOM PLATE. (SHIPYARD)

DO NOT PAINT THE RADIATION SURFACE

1.5 System Configuration

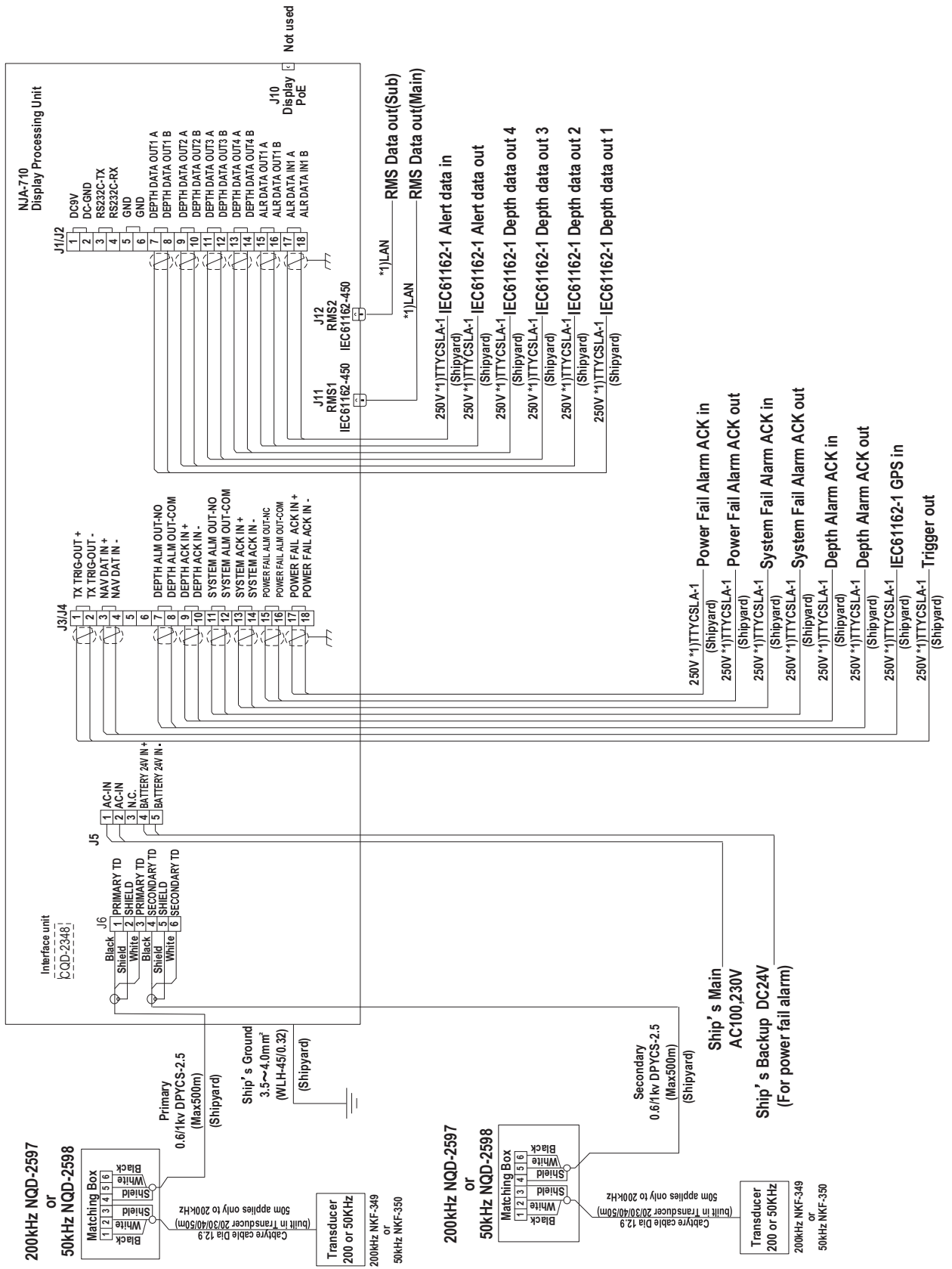

1.6 Interconnection Diagram

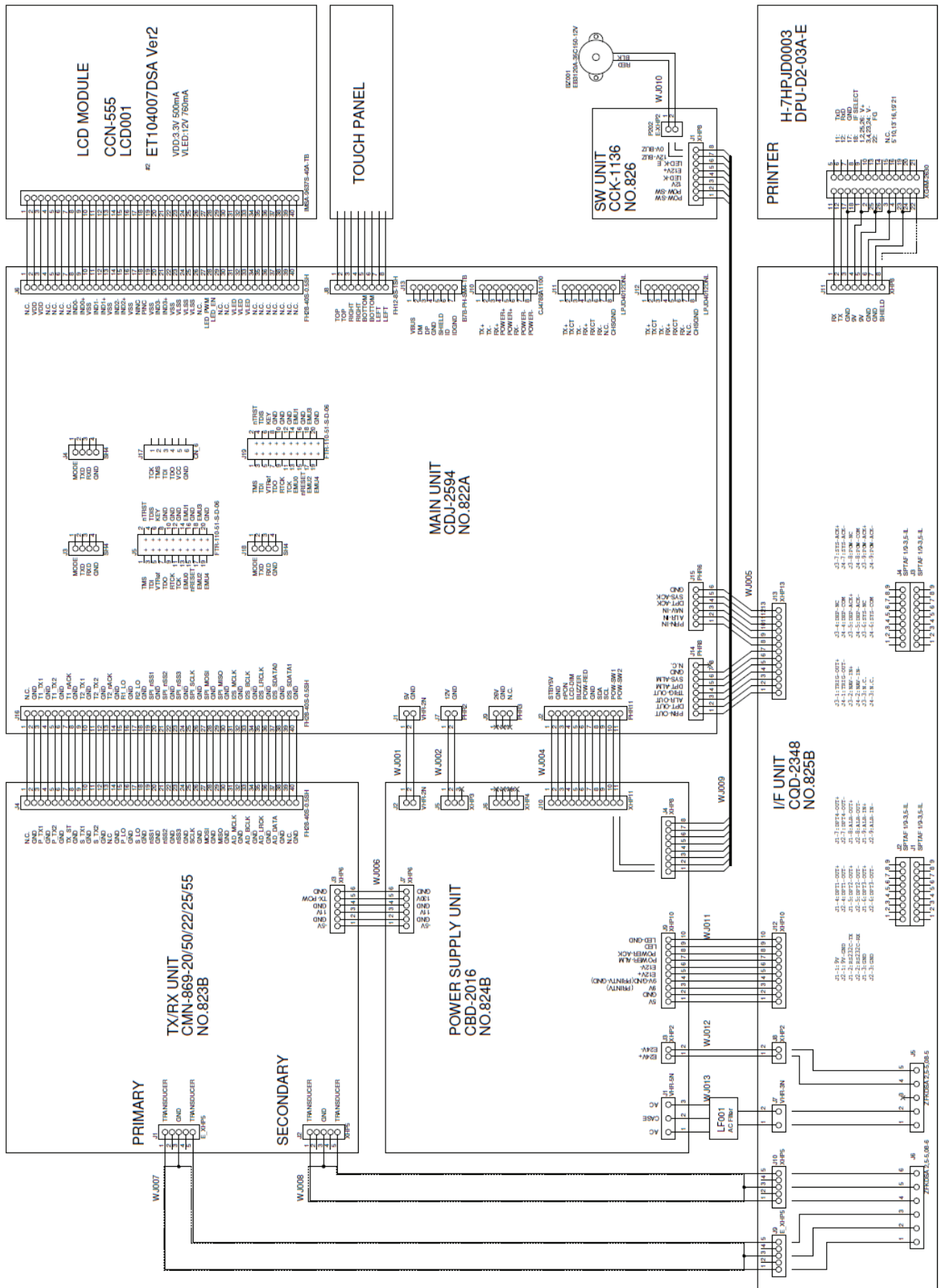

JFE-700(NJA-710) inter connection

(Blank page)

2. Control Panel

This section describes the names and functions of the control panel and its controls. The screen shown below is defined as the main screen.

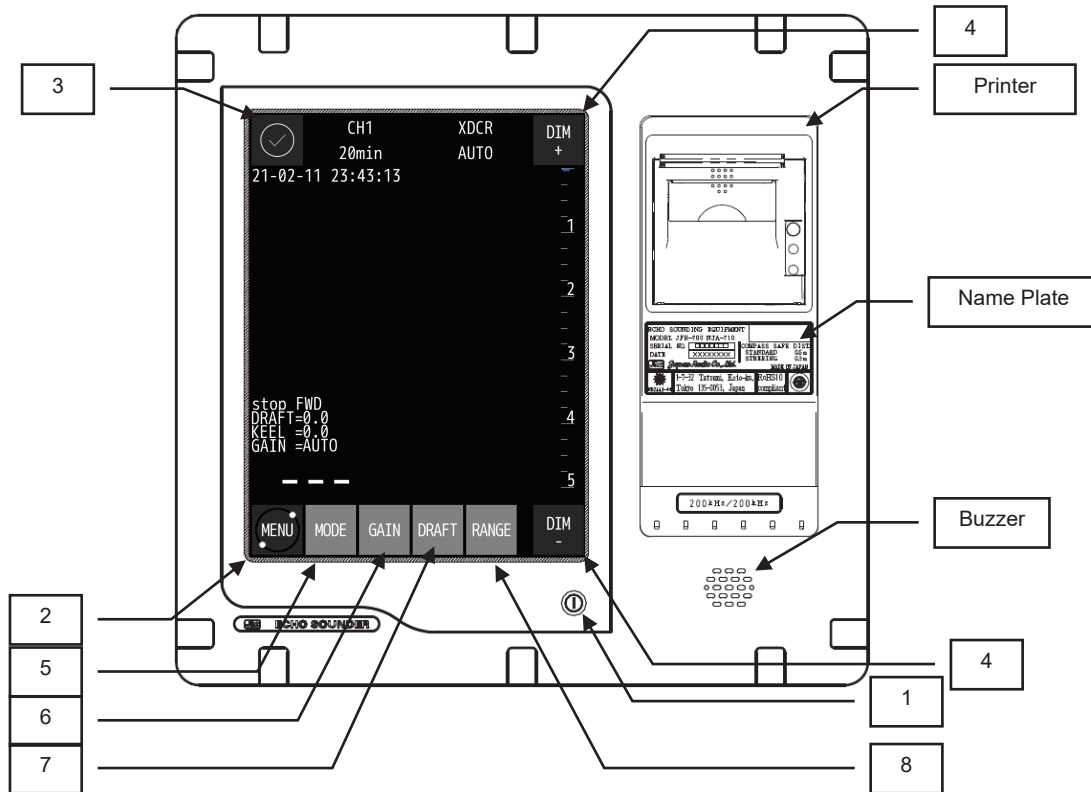

Figure 2-1 Display processing unit and Main screen

No.	Key	Function
1	①	Switches the equipment power on and off. Turn on and off: Press ① button
2	MENU	Displays the menu screen. To return the main screen, press the MAIN key since the MENU key will change to the MAIN key.
3	☑	When occurring alert, the icon will change depend on alert status. And alert content will be displayed to the right of the icon.
4	DIM+/DIM-	Adjusts the screen brilliance.
5	MODE	Switches the display modes in order of STD mode, HIST mode, DOCKING mode repeatedly.
6	GAIN	Adjusts the sensitivity high or low.
7	DRAFT	Sets the draft.
8	RANGE	Switches the depth range to shallow or deep.

Note:

When the power is turned on by a breaker while all the power supply to the equipment is cut off, the equipment will automatically start up without pressing the power button. In this time, it may take one minute from the startup screen to the main screen.

(Blank page)

3. Display mode

3.1 Standard mode

Standard mode displays real time sounding echoes

[Sample screen at single frequency]

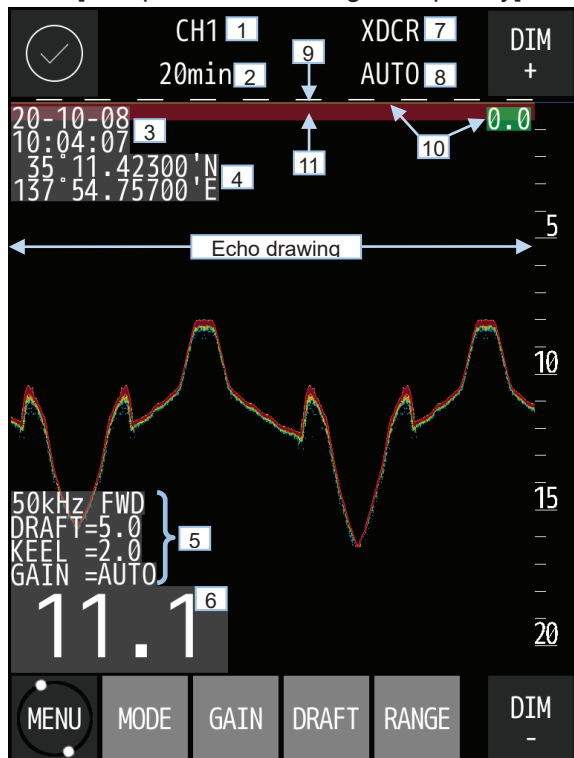

[Sample screen at dual frequency]

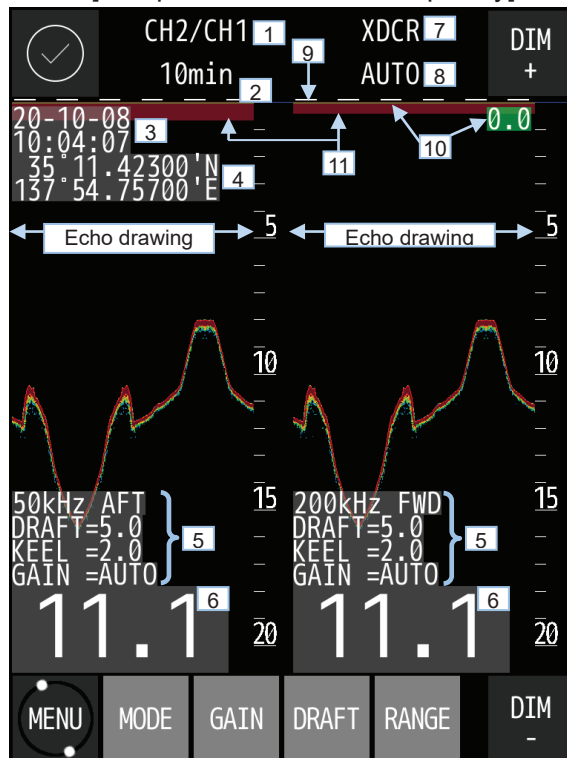

No.	Function	Description
1	Display mode	The current display mode and CH number are displayed.
2	Display time	The scroll time of the echo drawing area is displayed.
3	Date and time	Date and time information from GPS are displayed. When not connected, the internal clock will be displayed.
4	Latitude / Longitude	Latitude / Longitude from GPS is displayed.
5	Frequency and equipment position	The frequency and equipment position of the transducer are displayed.
	Draft value	The entered draft value is displayed.
	Keel value	The entered keel value is displayed.
	Gain value	The current gain value is displayed. "Auto" is displayed when auto gain is selected.
6	Depth value	The current water depth value is displayed digitally. When the depth alert is generated, the color of depth value is changed to red. When the seabed lost alert is generated, the color of depth value is changed to orange. Note: The color of depth value is changed to red or orange only when the software version is R01.00.060 or later.
7	Depth display setting	The currently selected depth display setting is displayed.
8	Range	The current display range is displayed. "Auto" is displayed when auto range is selected.
9	Minutes mark	Displayed at 1-minute intervals in echo drawing area. The length of the mark is 1 minute.
10	Depth cursor	Displays the depth cursor and its water depth value.
11	Oscillation line	The transmission line from the transducer is drawn horizontally at the top of the echo drawing area.

Note:

- The display position at 2 frequencies changes depending on the transducer settings of CH1 and CH2 (Which CH is primary or secondary depends on the specifications of each ship).
- FWD sounding data is displayed on the right side.
- LAT/LON display needs to connect position data device.

3.2 History mode

History mode displays past 3hours, 6 hours, 12 hours, 24hours depth graph and real time sounding.

[Sample screen at single frequency]

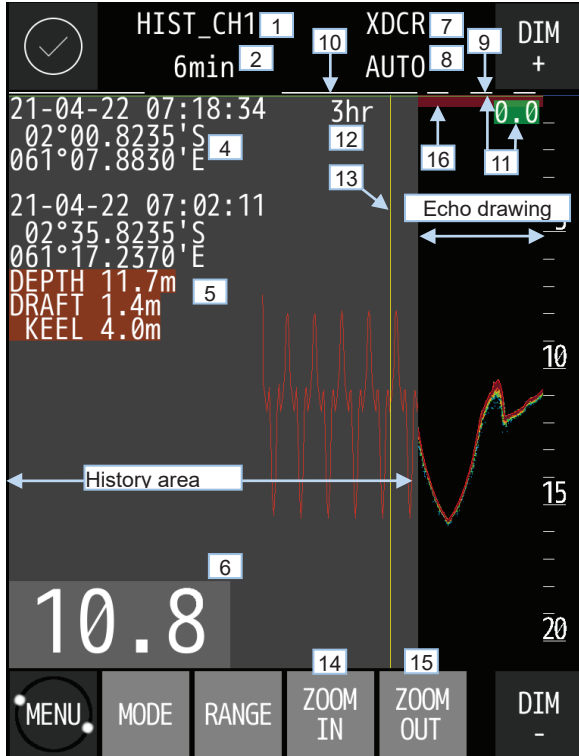

[Sample screen at dual frequency]

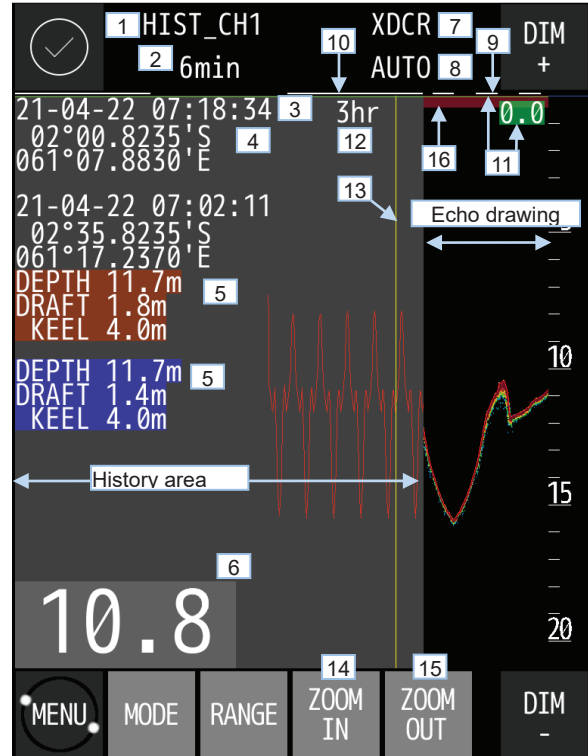

No.	Function	Description
1	Display mode	The current display mode and CH number are displayed.
2	Display time	The scroll time of the echo drawing area is displayed.
3	Date and time	Date and time information from GPS are displayed. When not connected, the internal clock will be displayed.
4	Latitude / Longitude	Latitude / Longitude from GPS is displayed.
5	Time cursor data	Displays the depth graph data pointed to by the time cursor. CH1 is brown and CH2 is blue. The data are Time/Position/Depth/Draft/Keel.
6	Depth value	The current water depth value is displayed digitally. When the depth alert is generated, the color of depth value is changed to red. When the seabed lost alert is generated, the color of depth value is changed to orange. Note: The color of depth value is changed to red or orange only when the software version is R01.00.060 or later.
7	Depth display setting	The currently selected depth display setting is displayed.
8	Range	The current display range is displayed. "Auto" is displayed when auto range is selected.
9	Minutes mark	Displayed at 1-minute intervals in echo drawing area. The length of the mark is 1 minute.
10	Hour mark	Displayed at 1-hour intervals in history area. The length of the mark is 1 hour.
11	Depth cursor	Displays the depth cursor and its water depth value.
12	History time interval	The scroll time of the history area is displayed.
13	Time cursor	The time cursor in the history area.
14	ZOOM IN	The history display time is shortened (5 steps of 48h → 24h → 12h → 6h → 3h)
15	ZOOM OUT	The history display time will be longer (5 levels of 3h → 6h → 12h → 24h → 48h)
16	Oscillation line	The transmission line from the transducer is drawn horizontally at the top of the echo drawing area.

Note:

- LAT/LON display needs to connect position data device.

3. Display

3.3 Docking mode

The docking mode displays depth data bigger.

[Sample screen at single frequency]

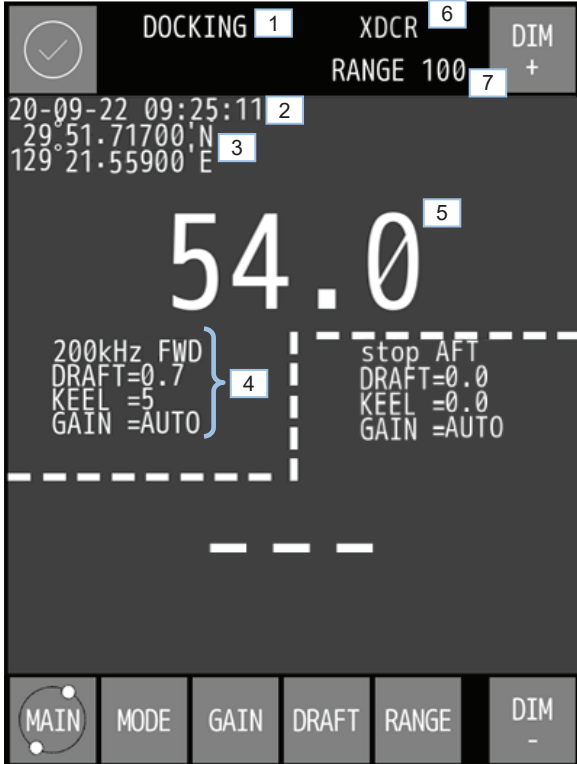

[Sample screen at dual frequency]

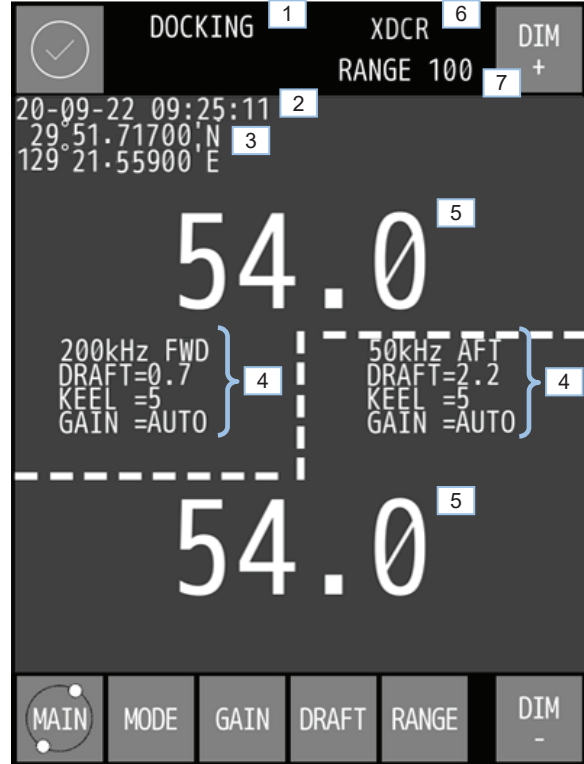

No.	Function	Description
1	Display mode	The current display mode is displayed.
2	Date and time	Date and time information from GPS are displayed. When not connected, the internal clock will be displayed.
3	Latitude / Longitude	Latitude / Longitude from GPS is displayed.
4	Frequency and equipment position	The frequency and equipment position of the transducer are displayed.
	Draft value	The entered draft value is displayed.
	Keel value	The entered keel value is displayed.
	Gain value	The current gain value is displayed. "Auto" is displayed when auto gain is selected.
5	Depth value	The current water depth value is displayed digitally. When the depth alert is generated, the color of depth value is changed to red. When the seabed lost alert is generated, the color of depth value is changed to orange. Note: The color of depth value is changed to red or orange only when the software version is R01.00.060 or later.
6	Depth display setting	The currently selected depth display setting is displayed.
7	Range	The range with the displayed water depth value in use is displayed. "Auto" is displayed when auto range is selected.

Note:



- LAT/LON display needs to connect position data device.

(Blank page)





4. Operation

4.1 Basic Operation









Turning Power ON/OFF

- To turn on power, press the  button.
- To turn off power, press the  button. A confirmation screen whether to turn off the power will be displayed. Touch the ✓ button.

Adjusting Control Panel Illumination [DIM+/DIM-]

- On echo sounder working adjust the brightness with  ,  on the screen.
- The brightness of the screen can be adjusted to 16 levels in each mode (DAY/DUSK/NIGHT).
- Whenever  is touched, brightness goes up and Whenever  is touched, brightness goes down.









Range Control [RANGE]

- The range change of this equipment is eight stages of 5, 10, 20, 50, 100, 200, 500, 800m.
- Touch  on main screen. The button color change to green and range menu is displayed.
- Range mode is displayed on the right side of main screen.
- Auto or manual range mode can be set with each   touch.
- Whenever  is touched, the range is switched to the deep end.
- Whenever  is touched, the range is switched to shallow one.
- When touch  or  ,  , auto range mode is released automatically and switch to the manual range.
- When auto range mode is canceled, the range setting is continued and doesn't return before the auto range mode.
- After setting the range. touch green RANGE button and range menu is closed.

Note

- Sea bottom might not be displayed according to the setting of draft.
- When sea bottom is not displayed, depth is not displayed.
- Auto range automatically switches the range so that the bottom 3/5 of the range scale shows the sea bottom.

Gain control [GAIN]

- Gain can be set to 41 stages of 0~40.
- Touch  on main screen. The button color change to green and gain menu is displayed.
- Auto gain mode or manual gain value is displayed with highlight on main screen when gain menu is displayed.
- Auto or manual gain mode can be set with each   touch.
- Whenever  is touched, the gain value is raised.
- Whenever  is touched, the gain value is lowered.
- When touch  or , , auto gain is canceled automatically and switch to the manual gain.
- When auto gain mode is canceled, it is operated the gain value at the time of canceling and doesn't return before the auto gain mode.
- After setting the gain. touch green GAIN button and gain menu is closed.
- When 2 transducers are installed, touch the green GAIN button again to switch to the CH2 setting.

◆ About the sensitivity setting

- Note that improper gain settings may result in incorrect depth measurement.
- The reflection from sea bottom is different according to the condition of sea bottom. The reflection weakens like sand and mud, etc. though a strong reflection returns like the bedrock.
- It becomes impossible to recognize sea bottom when the reflection is weak and the depth value might not be displayed. For this case, bottom of the sea is displayed in red by raising sensitivity. However, dirt and the plankton, etc. in the sea are mistaken when sensitivity is raised too much for sea bottom, it recognizes, and a wrong depth value might be displayed.
- As for the setting of sensitivity, extent to which sea bottom is displayed by a red or an orange color is proper.

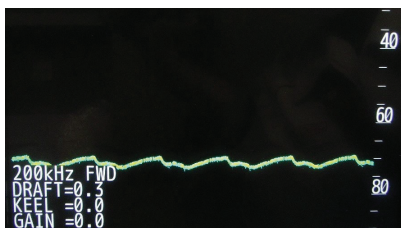

Sensitivity is too low.

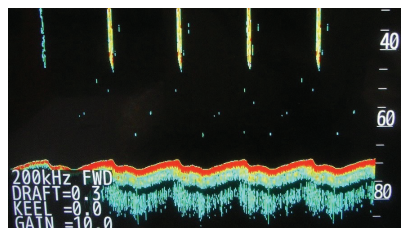

When sea bottom is a red or an orange color, the display sensitivity is proper.

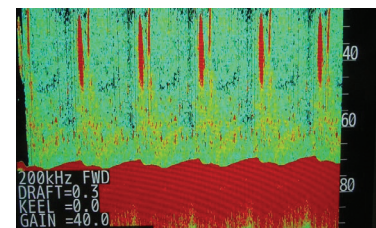

Sensitivity is too high.

Note

- When setting to an auto gain, the STC curve becomes "LONG" regardless of the setting of STC.

Selecting Display Mode [MODE]

- Each time with  touch, the display mode changes.

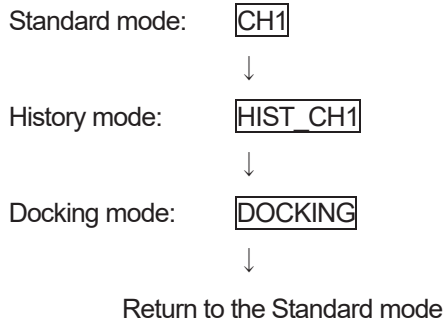

Single frequency: Each time with  touch, the display mode changes as follows.

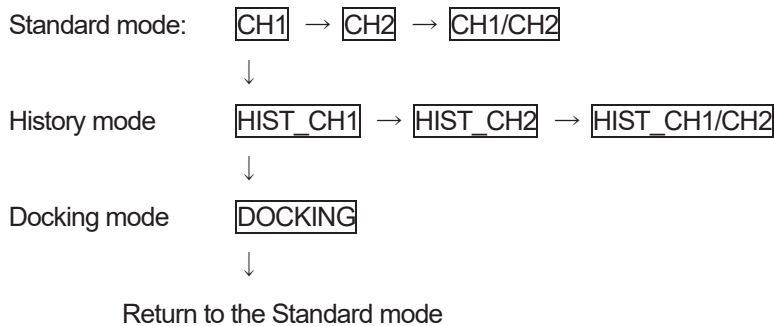

Dual frequency: Each time with  touch, the display mode changes as follows.





Draft control [DRAFT]

- Draft can be set to 0~50m in 0.1 step.
- Touch  on main screen. The button color change to green and draft menu is displayed.
- Draft value is displayed with highlight on main screen.
- Whenever  is touched, the draft value is raised.
- Whenever  is touched, the draft value is lowered.
- After setting the draft. touch green DRAFT button and gain menu is closed.
- When 2 transducers are installed, touch the green DRAFT button again to switch to the CH2 setting.

Displaying Menu [MENU]

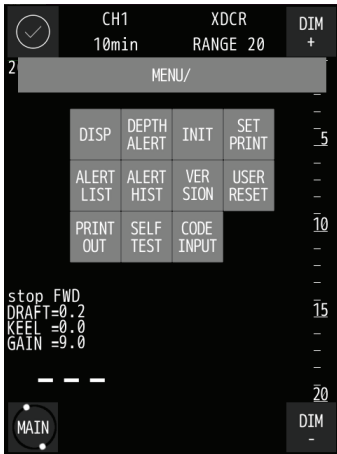
Displays the menu for setting various functions. Touch  button on the main screen.





- Each Item are selected by touch.
- Select the required item to display the setting menu for that item.
- When it returns to the main screen, touch .

Up and Down Key Cursor [CURSOR]

◆ When mode is a standard/history mode

- Depth cursor is displayed according to cursor mode setting (Refer to 4.3 Display Setting-Setting Cursor Display)

- When the  is touched, the depth cursor is moved to shallow one.

- When the  is touched, the depth cursor is moved to the deep end.

- The depth of the depth cursor doesn't display below the decimal point at 100m or more.

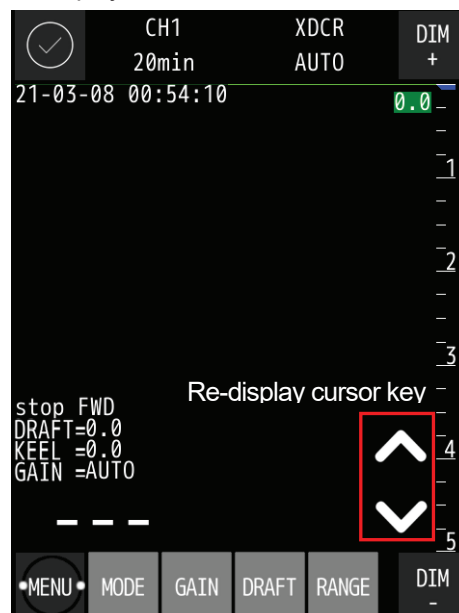

When the depth cursor deviates from the range scale due to range changing, the depth cursor is displayed at the bottom of the range scale.

- When the depth cursor is displayed, tap it in the echo drawing area to move the depth cursor to that area.
- When the key disappears, tap the screen of scale area to redisplay it.



Right and Left Key of Cursor [CURSOR]

◆ When it is a history mode

- When the  is touched, a time cursor is moved left, and it moves accelerating when keeping touching it.
- When the  is touched, a time cursor is moved right, and it moves accelerating when keeping touching it.
- Information of a time point to which a time cursor is displayed is displayed in the screen.
- Display information: Depth/Draft/Keel correction/Date/Time/Latitude Longitude
- The position where a time cursor is displayed doesn't scroll and is fixed. Therefore, when the history screen scrolls, display information is updated.
- When the time cursor is displayed, tap it in the history area to move the time cursor to that area.
- When the key disappears, tap the screen to redisplay it.

◆ When menu is displayed

-  : When submenu is displayed, returns to the previous menu.



4.2 Menu List

Menu Tree



MENU

DISP	
— SCROLL SPEED	SLOW <u>STD</u> FAST
— NOISE REJECT	0 1 2 3 <u>4</u> 5 6 7 8 9 10
— IR	OFF <u>IR1</u> IR2 IR3 AUTO
— CURSOR	OFF ON <u>AUTO</u>
— BOTTOM LINE	<u>OFF</u> ON
— DEPTH DISP MODE	SURF <u>XDCR</u> KEEL
— DAY NIGHT	<u>DAY</u> DUSK NIGHT
— LAT/LON	<u>OFF</u> ON
DEPTH ALERT	
	Numerical value input (<u>0.0</u> ~ 99.9)
INIT	
— COLOR	<u>7color + BLACK</u> 7color + WHITE 7color + BLUE MONO AMBER MONO YELLOW MONO WHITE
— DAY	<u>7color + BLACK</u> 7color + WHITE 7color + BLUE MONO AMBER MONO YELLOW MONO WHITE
— DUSK	<u>7color + BLACK</u> 7color + WHITE 7color + BLUE MONO AMBER MONO YELLOW MONO WHITE
— NIGHT	<u>7color + BLACK</u> 7color + WHITE 7color + BLUE MONO AMBER MONO YELLOW MONO WHITE
— DATE TIME	
— DATE	YYYY/MM/DD
— TIME	HH:MM:SS
— DIFF	Up to ±14:00
— FORMAT	<u>YY-MM-DD</u> DD MM,'YY MM DD,'YY
— 12/24h	12hr <u>24hr</u>
— GPS SYNC	OFF <u>ON</u>
— TOUCH PANEL CAL	
SET PRINT	
— PRINT MODE	<u>COPY</u> HISTORY LOG
— PRINT CYCLE (LOG)	<u>OFF</u> 0.5min 1min 2min 5min 10min
— PRINT LENGTH (LOG)	<u>10min</u> 20min 30min 1hr 2hr
ALERT LIST	
ALERT HIST	
VERSION	
USER RESET	
PRINT OUT	
SELF TEST	
— DEMO MODE	
— CONT UNIT	
— LCD UNIT	
— TOUCH PANEL UNIT	
— PRINT TEST	
— ALERT TEST	
— ALL	
— DEPTH ALERT	
— LOST DEPTH	
— WEAK ECHO TX F	
— WEAK ECHO TXA	
— WEAK ECHO RX F	
— WEAK ECHO RX A	
— NO PAPER	
— LOST PRINT	
— LOG MEMORY FAIL	
— LOST PROC.(Only JFE-400)	
— BUZZER TEST	
— TRANSDUCER	
— CH1	
— CH2	
CODE INPUT	*For service engineer menu

4.3 Display Setting

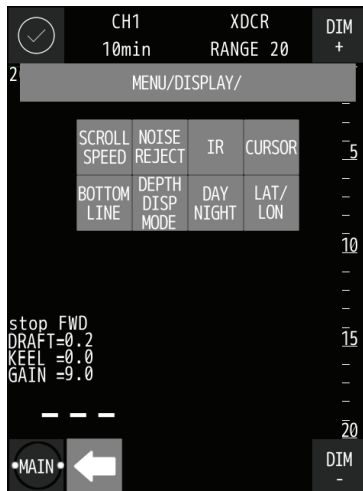
Touch  and , the following menu will be displayed.







- Select the required item to display the settings.
- When  is touched, return to previous menu
- When  is touched in each sub menu, selected content or setting value is registered in system.
- When  is touched in each menu, return to submenu without registering setting.

Selecting Image Scrolling Speed

◎The real time echo image scroll speed is selectable.



- Touch  and the settings will be displayed.
Set content: SLOW/STD/FAST
- Change the settings with , .
- After setting, touch .

Noise Rejection

☉ The generation of this noise is decreased when a weak noise to the entire screen occurs and the screen is hard to see.



- Touch **NOISE REJECT** and the settings will be displayed.

Set content: 0/1/2/3/4/5/6/7/8/9/10

- Touch **+** to increase the value and **-** to decrease it.
- The ability to decrease the noise as the numerical value increases strengthens though "0" doesn't have the ability to decrease.
- After setting, touch **✓**.

Interference Rejection

☉ The interference noise by another ship displayed on the screen is reduced.



- Touch **IR** and the settings will be displayed.

Set content: OFF/IR1/IR2/IR3/AUTO

- Change the settings with **+**, **-**.
- The ability to do the interference prevention processing strengthens while switching to "IR1 → IR2 → IR3 → AUTO" though the interference prevention processing is not done in "OFF".
- After setting, touch **✓**.

Setting Cursor Display

⊙ The cursor display method in a standard mode and a history mode is selected.



- Touch **CURSOR** and the settings will be displayed.

Set content : OFF/ON/AUTO

- OFF : The Depth cursor is not always displayed
- ON : The Depth cursor is always displayed.
- AUTO : The Depth cursor disappears from the screen when the non-operation time reaches 30 seconds. When the depth cursor disappears, tap the screen to redisplay it.

- Change the settings with , .

- After setting, touch .

- Depth cursor can move to the depth of touch position when depth cursor is displayed.

- After cursor moving ,use  and  for adjusting depth cursor.

Display setting of sea bottom line

⊙ Select whether to simplify the sea bottom echo notation.



- Touch **BOTTOM LINE** and the settings will be displayed.

Set content : OFF/ON

- OFF : Normal echo display.
- ON : Shows a red line on the edge of the sea bottom echo.

- Change the settings with , .

- After setting, touch .

Setting Depth Display

◎The standard when the depth value is displayed is selected.



- Touch **DEPTH DISP MODE** and the settings will be displayed.

Set content : SURF/KEEL/XDCR

SURF : The record and the depth value in which the draft adjusted value is considered are displayed.

KEEL : The record and the depth value in which the keel correction value is considered are displayed.

XDCR : The record and the depth value right under the transducer are displayed.

- Change the settings with **+**, **-**.

- After setting, touch

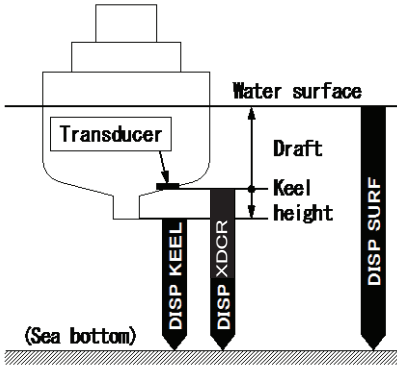

Switching the display colors of the day and night screen

☉Select a setting value to change the display color.



- Touch  and the settings will be displayed.

Set content : DAY/DUSK/NIGHT

DAY : Set the display color for daytime.

DUSK : Set the display color of dim lighting such as early morning or evening.

NIGHT : Set the display color scheme for night.

- The screen color can be set individually in the menu.

* See the COLOR item in the INITIAL menu.

- Change the settings with , .

- After setting, touch .

Note:

When the display color is switched, brightness will automatically return to the default brightness value of each display color.

Switching latitude and longitude display

☉Select whether to display the latitude and longitude information.



- Touch  and the settings will be displayed.

Set content : OFF/ON

OFF : Not display latitude and longitude information on the screen.

ON : Displays latitude and longitude information on the screen.



- Change the settings with , .

- After setting, touch .



Note:

LAT/LON display needs to connect position data device.

4.4 Setting Depth Alert

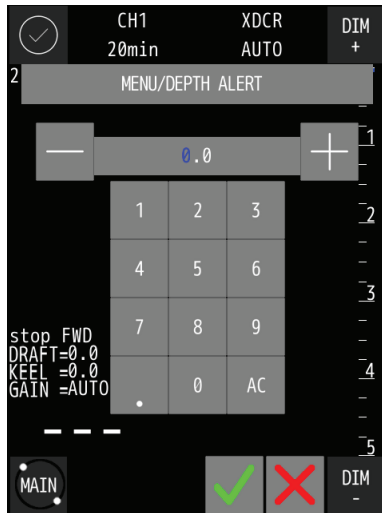

Touch  and , the settings will be displayed. Depth where the depth alert starts is set.

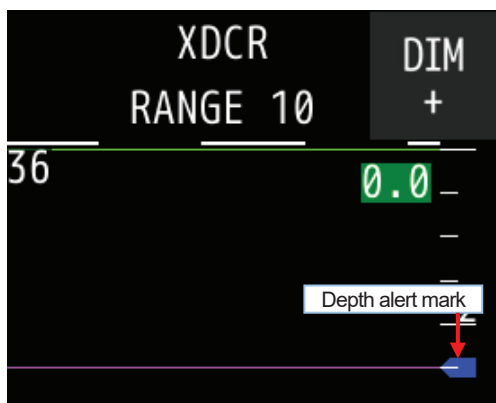

- Change the setting contents by entering a numerical value or , .
- Depth can be set up to 99.9m by a 0.1m unit.
- When depth is set and the depth alert is made "ON", the depth alert mark is displayed at the set depth position on the right of the range scale. This mark is not displayed to make the depth alert "OFF".
- When the alert depth is set to 10.0m, alert starts by 10.0m.
- When sea bottom becomes deeper than a set value after the depth alert starts, the alert will be canceled.
- After setting, touch .



4.5 Initial Setting

- Touch  and , the following menu will be displayed.





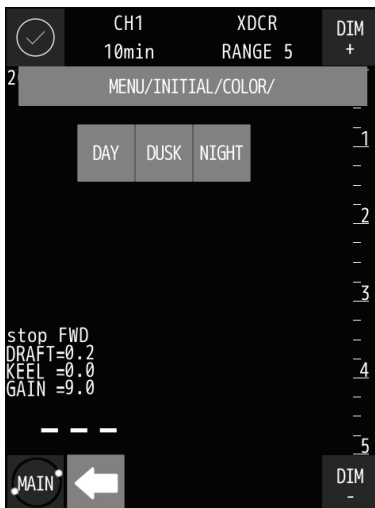

- Select the required item to display the settings.
- When  is touched, return to previous menu

Change screen color

◎Set the screen color of DAY/DASK/NIGHT



- Touch  and the following menu will be displayed
- Select the required item to display the settings.
- When  is touched, return to previous menu
- When  is touched in each sub menu, selected content or setting value is registered in system.
- When  is touched in each menu, return to submenu without registering setting.

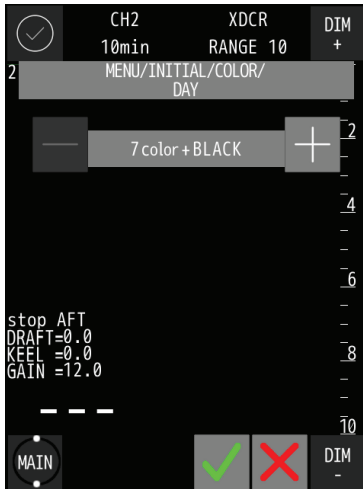

● DAY

⊙Set the color scheme when [DAY] is selected in the DAY/DUSK/NIGHT settings.



- Touch **DAY** and the settings will be displayed.

7color + BLACK : Echo color is 7colors and screen is black.
 7color + BLUE : Echo color is 7colors and screen is blue.
 7color + WHITE : Echo color is 7colors and screen is white.
 MONO AMBER : Echo color is amber gradation and screen is black.
 MONO YELLOW : Echo color is yellow gradation and screen is black.
 MONO WHITE : Echo color is white gradation and screen is black.

- Change the settings with , .
- After setting, touch .

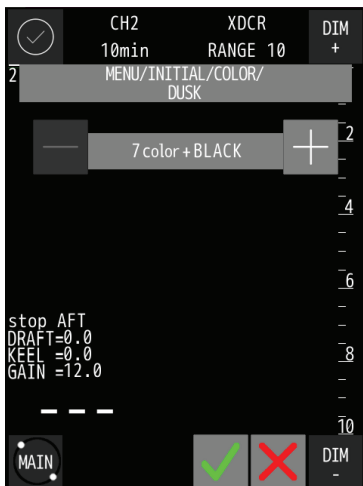

● DUSK

⊙Set the color scheme when [DUSK] is selected in the DAY/DUSK/NIGHT settings.



- Touch **DUSK** and the settings will be displayed.

7color + BLACK : Echo color is 7colors and screen is black.
 7color + BLUE : Echo color is 7colors and screen is blue.
 7color + WHITE : Echo color is 7colors and screen is white.
 MONO AMBER : Echo color is amber gradation and screen is black.
 MONO YELLOW : Echo color is yellow gradation and screen is black.
 MONO WHITE : Echo color is white gradation and screen is black.

- Change the settings with , .
- After setting, touch .

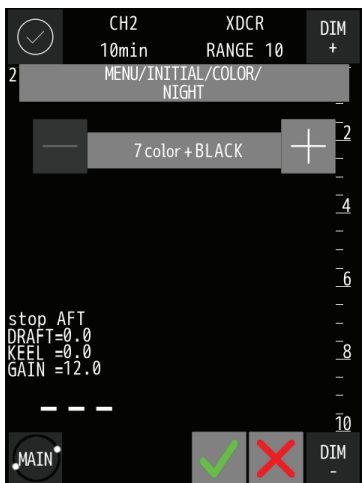

● NIGHT

⊙Set the color scheme when [NIGHT] is selected in the DAY/DUSK/NIGHT settings.



- Touch **NIGHT** and the settings will be displayed.

7color + BLACK : Echo color is 7colors and screen is black.
 7color + BLUE : Echo color is 7colors and screen is blue.
 7color + WHITE : Echo color is 7colors and screen is white.
 MONO AMBER : Echo color is amber gradation and screen is black.
 MONO YELLOW : Echo color is yellow gradation and screen is black.
 MONO WHITE : Echo color is white gradation and screen is black.

- Change the settings with , .
- After setting, touch .

Setting Adjustment of Date and Time

◎Date/Time/Time difference/GPS synchronization is set.

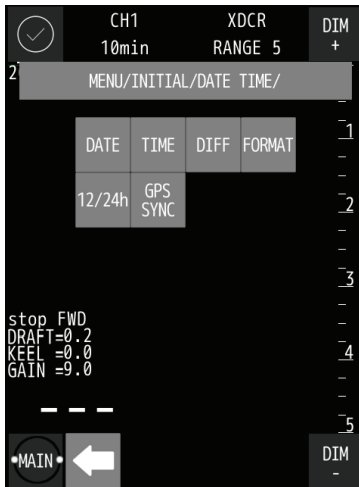

- Touch and the following menu will be displayed.
- Select the required item to display the settings.
- When is touched, return to previous menu
- When is touched in each sub menu, selected content or setting value is registered in system.
- When is touched in each menu, return to submenu without registering setting.

● DATE (Date)

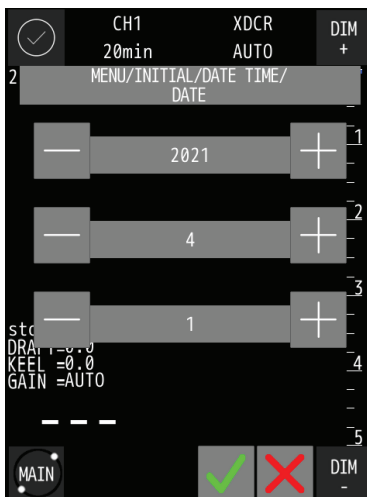

- Touch and the setting will be displayed.
- The setting items are year / month / day in order from the top of the screen.
- Touch to increase the value and to decrease it.
- After setting, touch .



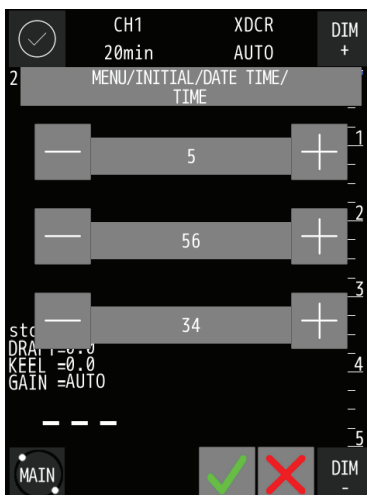

● TIME (Time)

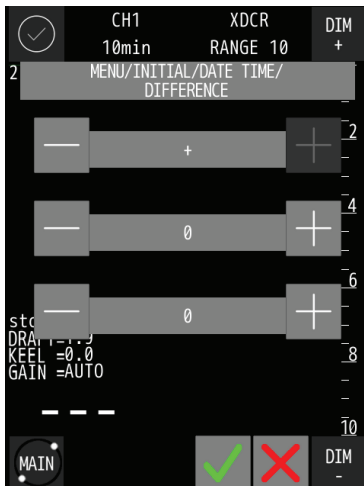

- Touch and the setting will be displayed.
- The setting items are hour / minute / second in order from the top of the screen.
- Touch to increase the value and to decrease it.
- After setting, touch .





- DIFF (Time difference)



- Touch  and the setting will be displayed.
- The setting items are ± / hour / minute in order from the top of the screen.
- Touch  to increase the value and  to decrease it.
- When the time difference is "±0", it is recognized as UTC.
- After setting, touch .





- FORMAT (Date display)



- Touch  and the settings will be displayed.
- Set content : YY-MM-DD DD MM,'YY MM DD,'YY is displayed.
 - YY-MM-DD : Change the notation to YY-MM-DD
 - DD MM,'YY : Change the notation to DD MM,'YY
 - MM DD,'YY : Change the notation to MM DD,'YY
- Change the settings with , .
- After setting, touch .

- 12/24 (Time notation)



- Touch  the settings will be displayed.
- Set content : 12/24
 - 12 : 12 hour notation.
 - 24 : 24 hour notation.
- Change the settings with , .
- After setting, touch .

- GPS SYNC (GPS synchronization)



- Touch  the settings will be displayed.

Set content : OFF/ON

- **OFF** : An internal clock is used.
- **ON** : Uses time information from GPS. Also, when the internal clock of the processing unit deviates by 30 seconds or more, the internal clock is corrected to the time information from GPS.

- Change the settings with , .



- After setting, touch .

Touch Panel Calibration

◎Touch position correction







When the touch position and the reaction position are out of alignment, it can be corrected by performing calibration.

- Touch  and the calibration screen will be displayed.
- Touch , which turns red in the order of upper left → upper right → lower left → lower right → center of the screen. The position is corrected.

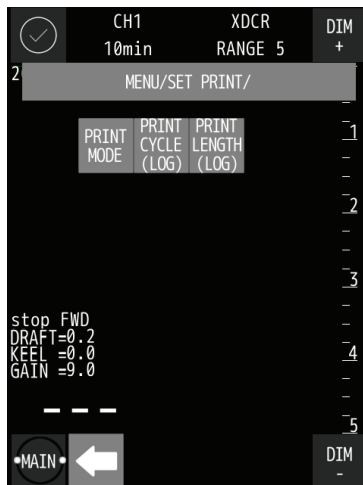
4.6 Printer Control Setting

Touch  and , the following menu will be displayed.





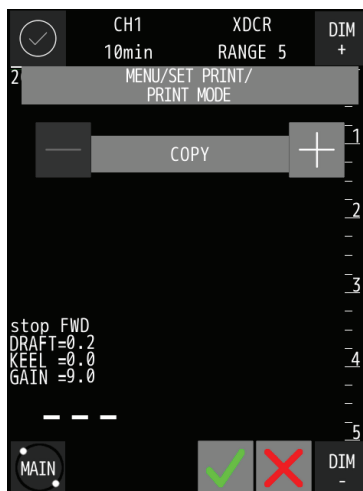

- Select the required item to display the settings.
- When  is touched, return to previous menu
- When  is touched in each sub menu, selected content or setting value is registered in system.
- When  is touched in each menu, return to submenu without registering setting.

Setting Print Mode

This item selects print out mode by three items.





- Touch  and the setting will be displayed.
Detail item : COPY/HISTORY/LOG

{	COPY :	} Refer to next page
	HISTORY :	
	LOG :	
- Change the settings with  .
- After setting, touch .

- COPY :** A present screen display is printed. The direction of paper feed is length against the screen.
- HISTORY :** All the memorized depth data is graphically printed. The direction of paper feed is time.
 Secondary data is printed following primary in display screen for dual frequency.
 On single frequency mode, only displaying frequency data is printed.
 After the graphical printout, the data of START information and END information is printed.
 The information data is same one as time cursor display information.
 When the history is long, it takes time to print the entire history.
- LOG :** This printout is available only the history display mode. On history display mode, move time cursor by **<** or **>** key to select the center of LOG printout. LOG graphical printout length is set by "PRINT LENGTH(LOG)" menu.(10min/ 20min/ 30min/ 1hr/ 2hr)
 A time cursor is displayed in the graphical printout. The direction of paper feed is time.
 After the graphical printout, the data of START information, CURSOR information and END information is printed. Each information data is same one as time cursor display information.

Print out examples

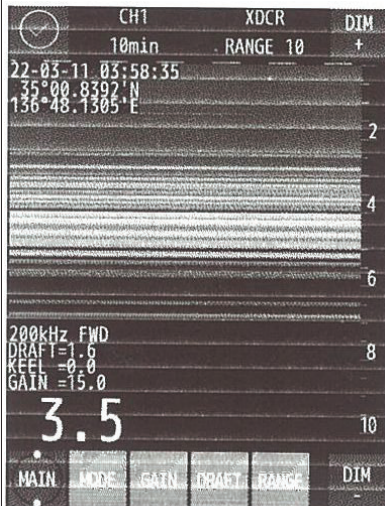
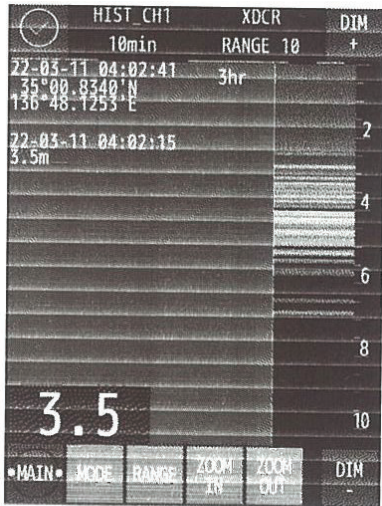
1. COPY print mode

STANDARD Single frequency	HISTORY Single frequency	DOCKING Dual frequency
 <p>CH1 XDCR DTM 10min RANGE 10 + 22-03-11 03:58:35 35°00.8397'N 136°48.1305'E 2 4 6 8 10 200kHz FWD DRAFT=1.0 KEEL=0.0 GAIN=15.0 3.5 MAIN MODE GAIN DRAFT RANGE DTM</p> <p>- PRIMARY - DEPTH:3.5m DRAFT:1.0m KEEL:0.0m 22-03-11 03:58 UTC</p>	 <p>HIST_CH1 XDCR DTM 10min RANGE 10 + 22-03-11 04:02:41 3hr 35°00.8340'N 136°48.1253'E 2 4 6 8 10 3.5 MAIN MODE RANGE ZOOM IN ZOOM OUT DTM</p> <p>- PRIMARY - DEPTH:3.5m DRAFT:1.0m KEEL:0.0m 22-03-11 04:02 UTC</p>	 <p>DOCKING XDCR DTM 10min RANGE 10 + 22-03-11 04:06:28 35°00.8291'N 136°48.1206'E 3.5 200kHz FWD DRAFT=1.0 KEEL=0.0 GAIN=15.0 50kHz AFT DRAFT=2.4 KEEL=0.0 GAIN=14.0 3.4 MAIN MODE GAIN DRAFT RANGE DTM</p>

2. HISTORY print mode

Depth data and graph

— PRIMARY END —
DEPTH: 2.2m
KEEL: 0.0m
04/02/2021:
01:16 UTC:

— PRIMARY 20 —
DEPTH: 2.2m
KEEL: 0.0m
04/02/2021:
01:17 UTC:

— PRIMARY 19 —
DEPTH: 2.2m
KEEL: 0.0m
04/02/2021:
01:18 UTC:

— PRIMARY 18 —
DEPTH: 2.2m
KEEL: 0.0m
04/02/2021:
01:19 UTC:

— PRIMARY 17 —
DEPTH: 2.2m
KEEL: 0.0m
04/02/2021:
01:20 UTC:

— PRIMARY 16 —
DEPTH: 2.2m
KEEL: 0.0m
04/02/2021:
01:21 UTC:

— PRIMARY 15 —
DEPTH: 2.2m
KEEL: 0.0m
04/02/2021:
01:21 UTC:

— PRIMARY 14 —
DEPTH: 3.6m
KEEL: 0.0m
04/02/2021:
05:00 UTC:

— PRIMARY 13 —
DEPTH: 3.6m
KEEL: 0.0m
04/02/2021:
05:01 UTC:

— PRIMARY 12 —
DEPTH: 3.6m
KEEL: 0.0m
04/02/2022:
05:01 UTC:

— PRIMARY 11 —
DEPTH: 3.6m
KEEL: 0.0m
05/03/2022:
07:53 UTC:

— PRIMARY 10 —
DEPTH: 3.6m
KEEL: 0.0m
05/03/2022:
09:11 UTC:

— PRIMARY 9 —
DEPTH: 3.6m
KEEL: 0.0m
05/03/2022:
11:38 UTC:

— PRIMARY 8 —
DEPTH: 5.1m
KEEL: 0.0m
06/03/2022:
04:58 UTC:

— PRIMARY 7 —
DEPTH: 5.1m
KEEL: 0.0m
06/03/2022:
05:35 UTC:

— PRIMARY 6 —
DEPTH: 2.9m
KEEL: 0.0m
06/03/2022:
11:28 UTC:

— PRIMARY 5 —
DEPTH: 2.9m
KEEL: 0.0m
07/03/2022:
08:37 UTC:

— PRIMARY 4 —
DEPTH: 4.2m
KEEL: 0.0m
09/03/2022:
08:47 UTC:

— PRIMARY 3 —
DEPTH: 4.2m
KEEL: 0.0m
09/03/2022:
09:08 UTC:

— PRIMARY 2 —
DEPTH: 3.7m
KEEL: 0.0m
09/03/2022:
11:43 UTC:

— PRIMARY 1 —
DEPTH: 4.2m
KEEL: 0.0m
09/03/2022:
11:50 UTC:

— PRIMARY START —
DEPTH: 3.4m
KEEL: 0.0m
11/03/2022:
04:07 UTC:

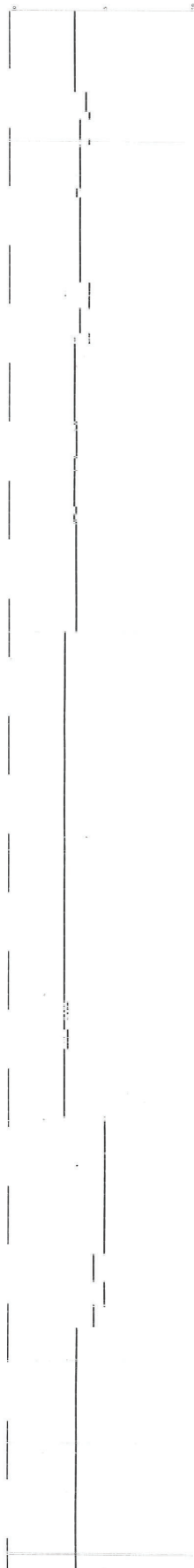

3. LOG print mode

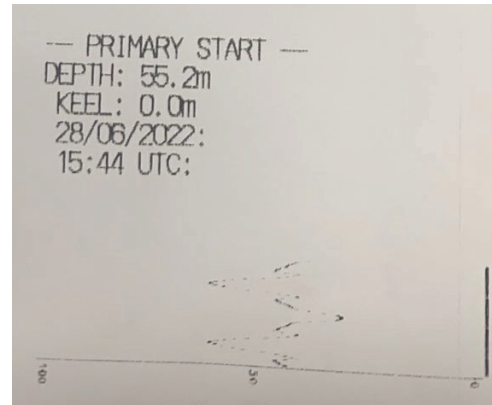





4. Operation

Setting Log Book Print

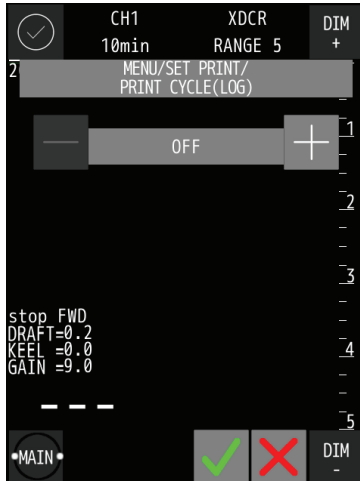
⊙ This item selects automatic LOG book print mode.

When select this interval setting menu to 0.5min, 1min, 2min, 5min, 10min, depth data and time will automatically print with every selected interval. When GPS position data is connected, LAT/LON position data would print.







- Touch  and the setting will be displayed.
- Detail item : **OFF**/0.5min/1min/2min/5min/10min
- Change the settings with , .
- After setting, touch .

01/09/2021	UTC	DRAFT:	0.0m	0.0m
TIME	FWD	AFT	LAT/LON	
21:39	70.3m	70.5m	36° 06.839N	139° 46.637E
21:40	70.6m	70.8m	36° 07.039N	139° 46.637E
21:41	71.0m	71.1m	36° 07.242N	139° 46.637E
21:42	70.0m	70.1m	36° 07.442N	139° 46.637E
21:43	69.0m	69.3m	36° 07.642N	139° 46.637E
21:44	68.6m	68.8m	36° 07.839N	139° 46.637E
21:45	70.3m	70.5m	36° 08.039N	139° 46.637E
21:46	70.8m	71.1m	36° 08.242N	139° 46.637E
21:47	70.8m	71.0m	36° 08.442N	139° 46.637E
21:48	69.8m	70.0m	36° 08.642N	139° 46.637E

Setting Log graphical printout Length

⊙ This item selects LOG graphical printout length on the HISTORY display mode with LOG print mode.





- Touch  and the setting will be displayed.
- Detail item : **10min**/20min/30min/1hr/2hr
- Change the settings with , .
- After setting, touch .

4.7 Checking system version

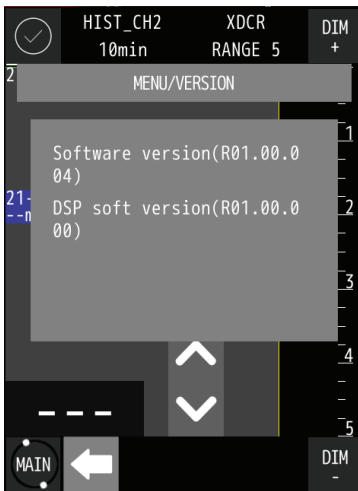
◎ Internal software version and DSP version are displayed.





- Touch  and the software and DSP version will be displayed.
- After confirming, touch .

4.8 Initializing menu settings

◎ Initialize user settings.







- Touch  and the confirmation screen will be displayed.
 - Touch  to start initialization.
 - To return to the previous screen without initializing, touch .
 - By initialization, RANGE, GAIN, and DRAFT will be as follows
 RANGE = AUTO
 GAIN = AUTO
 DRAFT = 0.0
- In addition, the values returned by the settings in MENU are as shown in the table below.

MENU	MENU 1	MENU 2	Return value
DISPLAY	SCROLL SPEED		STD
	NOISE REJECT		4
	INTERFERENCE		IR1
	CURSOR		AUTO
	BOTTOM LINE		OFF
	DEPTH DISPLAY MODE		XDCR
	DAY/NIGHT		DAY DUSK NIGHT
DEPTH ALERT			OFF
INITIAL	COLOR	DAY	7color + BLACK
		DUSK	7color + BLACK
		NIGHT	7color + BLACK
	DATE TIME	DIFF	±00:00
		FORMAT	YY-MM-DD
		12/24h	12hr 24hr
	GPS SYNC	ON	
SET PRINT	PRINT MODE		COPY
	PRINT CYCLE (LOG)		OFF
	PRINT LENGTH (LOG)		10min

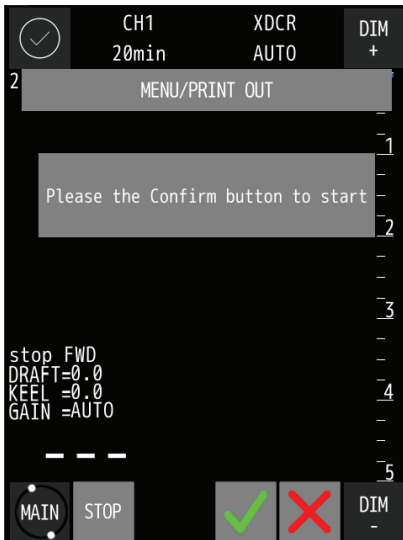

4.9 Print out menu

© The contents are printed according to the printer settings(Refer to 4.6 printer control setting).



- Touch  and the confirmation screen will be displayed.
- Touch  to start printing.
- Touch  to return to the previous screen without printing.

4.10 SELF TEST

© Touch  and , the following menu will be displayed.

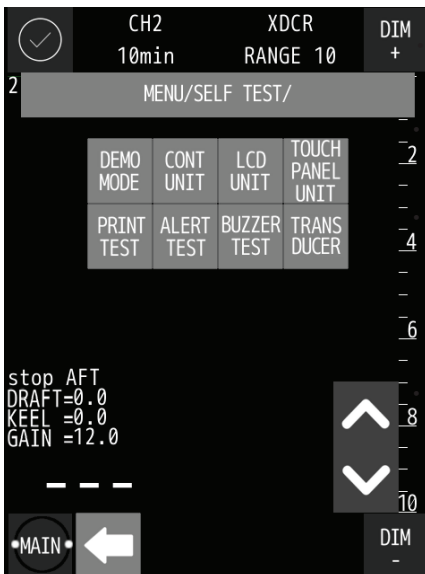

Select the required item to display the settings.

When  is touched, return to previous menu





When  is touched in each sub menu, selected content or setting value is registered in system.

When  is touched in each menu, return to submenu without registering setting.

Demo Mode

☉ Execute demonstration.



- Touch  and the setting will be displayed.
- Detail item : **OFF**/ON
- Change the settings with , .
- Touch  to start demonstration when setting is ON.
- During demo mode, the "In demo mode" window is displayed. Tap the window to hide it. In addition, character of DEMO is always displayed on the screen.





CAUTION

The sounding function cannot be used while in demo mode.

Self-test of Control Unit

☉ Self-testing RAM and ROM in Control Unit read/write.





- Touch  and the confirmation screen will be displayed.
- Touch  to start self-testing.

*When self-test result is error, contact us or your agency.

Self-test of LCD Unit

◎ Self-testing LCD Unit by displaying color pattern





- Touch  and the confirmation screen will be displayed.
- Touch  to start self-testing.
- Color pattern(black->red->green->blue->white) is displayed with screenful.

*When color pattern display is not correct, contact us or your agency.

Self-test of Touch Panel

◎ Self-testing Touch panel by sensing touch.





- Touch  and the confirmation screen will be displayed.
- Touch  to start self-testing.
- Screen change to all white and when you touch the screen, touching point change to green.

*When touching point is not correct, contact us or your agency.

Self-test of Printer

◎ Self-testing Printer by printing test pattern.



- Touch  and the confirmation screen will be displayed.
- Touch  to start self-testing.
- Test pattern is printed.





*When test pattern is not correct, contact us or your agency.

Self-test of Alert

Refer to 4.12 Alert Control for more details on each alert.

☉ Self-testing by simulating each alert.



- Touch  to display the alert for self-test.
- Select the required item to display the settings.
- When  is touched, return to previous menu
- When  is touched in each sub menu, selected content.
- When  is touched in each menu, return to submenu without registering setting.

Note:

Lost Proc. alert is supported only JFE-400(detect of disconnection of between processing unit and display unit)







CAUTION

Alert of self-testing will continue to appear unless turn the self-test alert setting to off.

• ALL





- Touch  and the setting will be displayed.
- Detail item : **OFF/ON**
- Change the settings with , .
- Touch  to start simulating alert when setting is ON.

[About generating alerts]

This function simulates only alerts that are set to be generated by equipment settings. See 4.12 Alert Control for details on the alerts.

● DEPTH ALERT





- Touch **DEPTH ALERT** and the setting will be displayed.
- Detail item : **OFF/ON**
- Change the settings with , .
- Touch  to start simulating alert when setting is ON.

* To use this function, it is necessary to turn on the DEPTH ALERT generation setting in the equipment settings. (Default is ON)

● LOST DEPTH





- Touch **LOST DEPTH** and the setting will be displayed.
- Detail item : **OFF/ON**
- Change the settings with , .
- Touch  to start simulating alert when setting is ON.

* To use this function, it is necessary to turn on the LOST DEPTH alert generation setting in advance in the equipment settings.

● WEAK ECHO TX F







- Touch **WEAK ECHO TX F** and the setting will be displayed.
- Detail item : **OFF/ON**
- Change the settings with , .
- Touch  to start simulating alert when setting is ON.

* To use this function, it is necessary to turn on the WEAK ECHO TX:FWD alert generation setting in advance in the equipment settings.

● WEAK ECHO TX A







- Touch  and the setting will be displayed.
- Detail item : OFF/ON
- Change the settings with , .
- Touch  to start simulating alert when setting is ON.

* To use this function, it is necessary to turn on the WEAK ECHO TX:AFT alert generation setting in advance in the equipment settings.

● WEAK ECHO RX F







- Touch  and the setting will be displayed.
- Detail item : OFF/ON
- Change the settings with , .
- Touch  to start simulating alert when setting is ON.

* To use this function, it is necessary to turn on the WEAK ECHO RX:FWD alert generation setting in advance in the equipment settings.

● WEAK ECHO RX A





- Touch  and the setting will be displayed.
- Detail item : OFF/ON
- Change the settings with , .
- Touch  to start simulating alert when setting is ON.

* To use this function, it is necessary to turn on the WEAK ECHO RX:AFT alert generation setting in advance in the equipment settings.

- No Paper





- Touch **NO PAPER** and the setting will be displayed.
- Detail item : **OFF/ON**
- Change the settings with , .
- Touch  to start simulating alert when setting is ON.

* To use this function, it is necessary to turn on the NO PAPER alert generation setting in advance in the equipment settings. (Default is ON)

- Lost Print





- Touch **LOST PRINT** and the setting will be displayed.
- Detail item : **OFF/ON**
- Change the settings with , .
- Touch  to start simulating alert when setting is ON.

* To use this function, it is necessary to turn on the LOST PRINTER alert generation setting in advance in the equipment settings. (Default is ON)

- Log memory fail





- Touch **LOG MEMORY FAIL** and the setting will be displayed.
- Detail item : **OFF/ON**
- Change the settings with , .
- Touch  to start simulating alert when setting is ON.

* To use this function, it is necessary to turn on the LOG MEMORY FAIL alert generation setting in advance in the equipment settings. (Default is ON)

Self-test of Buzzer Test

◎ Self-testing Buzzer.



- Touch  and the confirmation screen will be displayed.
- Touch  to start self-testing.

*When buzzer does not sound, contact us or your agency.

Self-test of TRANSDUCER

Touch **TRANSDUCER** to display a menu for selecting CH1 CH2. When select the CH to diagnose, a warning window is displayed. After reading the warning contents, touch  to start the self-test.

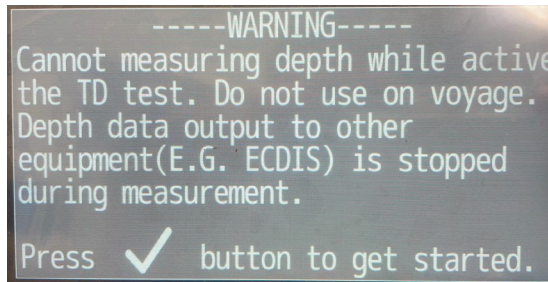
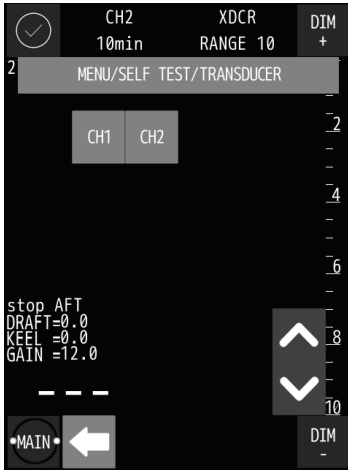

This function cannot completely identify the failure of the transducer. Use this as a guide to see when the transducer is operating normally.

When there is a chevron in the vicinity of the frequency used after checking the waveform, the operation of transducer is good.

When there is no chevron in the vicinity of the frequency used after checking the waveform or is flat, the transducer may be defective.

Take a picture of the bad waveform and contact us or your distributor. (Contact information is on the back cover)

● Good product

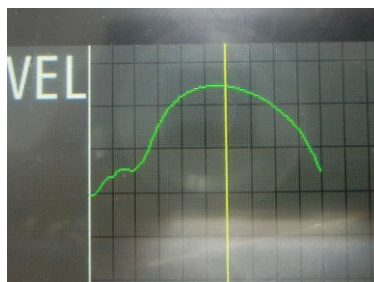
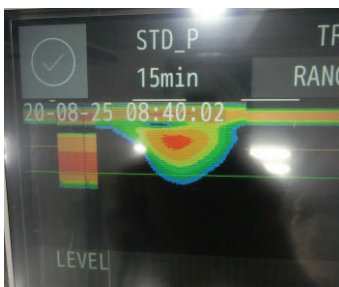

● Defective Product

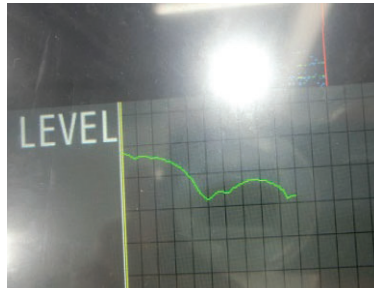
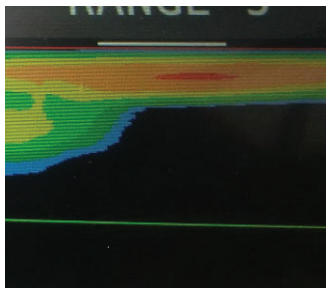



CAUTION

The sounding function cannot be used and depth data output to other equipment (E.G. ECDIS) is stopped while TRANSDUCER function of self-test is performed. Do not use this function during voyage. Carry out while the ship is moored.

4.11 Displaying of EQUIP menu

Touch  and , the following menu will be displayed.

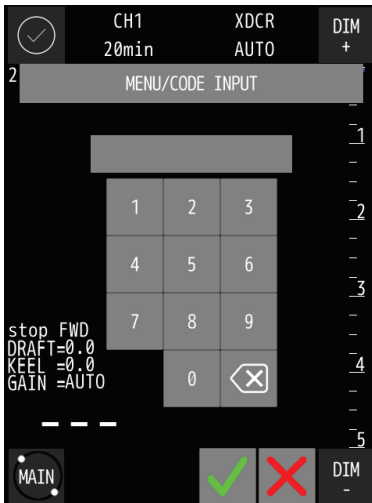

• It is not a menu for users.

• Enter the password and touch  to display the EQUIP menu on the main menu.

• To return to the previous screen without entering the password, touch .

4.12 Alert Control

Over view

This section describes the types, displays, and settings of each alert.

JFE-400/700 Echo Sounder displays alerts in accordance with IEC62923 Ed.1.0.

Alert priority is defined as three types according to its priority and severity as shown in the table below.

Priority	Description(severity)	Display Color	Sound	Display Status
Alarm	An alert indicating a state asking sailors to pay immediate attention and take immediate action.	Red	Present (repetitive)	Before acknowledgement: Blinking After acknowledgement: Lighting
Warning	An alert indicating that the state has changed, which although not immediately dangerous, but may become so in the near future if no action is taken. Warnings are alerts displayed for preventing possible future hazardous states.	Orange	Present (Once)	Before acknowledgement: Blinking After acknowledgement: Lighting
Caution	Although these are neither alarms nor warnings, these alerts indicate that it is necessary to pay more than normal attention to cautions, statuses, or to the supplied information.	Yellow	No Sound	Only Lighting

In addition, each alert is categorized as follows according to IEC62923-1:

Category A: alert for which graphical information at the task station directly assigned to the function generating the alert is necessary, as decision support for the evaluation of the alert related condition

Category B: alert where no additional information for decision support is necessary besides the information which can be presented at the CAM(central alert management) system.

List of generating alert

The following alerts are generated on JFE-400/700 Echo Sounder

No.	Name	Detail information on screen	Alert ID	Alert instance	Priority	Category	Responsibility Transfer	Escalation	Backup Navigator Call
1	DEPTH UNSAFE	"Install position" depth unsafe, avoid stranding	3031	1	Alarm	A	No	N/A	Yes
2	DEPTH UNSAFE	"Install position" depth unsafe, avoid stranding	3031	2	Alarm	A	No	N/A	Yes
3	LOST DEPTH	"Install position" lost bottom, check chart	10352	1	Warning	B	Yes	warning to warning	No
4	LOST DEPTH	"Install position" lost bottom, check chart	10352	2	Warning	B	Yes	warning to warning	No
5	NO PAPER	No paper of printer	10356	-	Caution	B	N/A	N/A	No
6	LOST PRINTER	Discommunication with printer	10359	-	Caution	B	N/A	N/A	No
7	WEAK ECHO TX	"Install position" transmission level down	10363	1	Caution	B	N/A	N/A	No
8	WEAK ECHO TX	"Install position" transmission level down	10363	2	Caution	B	N/A	N/A	No
9	WEAK ECHO RX	"Install position" receive sensitivity down	10365	1	Caution	B	N/A	N/A	No
10	WEAK ECHO RX	"Install position" receive sensitivity down	10365	2	Caution	B	N/A	N/A	No
11	LOST PROCESSOR	Processor and display unit com fail, check LAN cable	10353	-	Warning	B	Yes	warning to warning	No
12	LOG MEMORY FAIL	Cannot log Depth	10362	-	Caution	B	N/A	N/A	No

*The Transducer alerts related to FWD and AFT are generated depending on the installation position and number of installations about Transducer.

* Backup Navigator Call function are available when connected to the BNWAS (Bridge Navigational Alarm System).











* Responsibility Transfer function are available when connected to the CAM(Central Alert Management) system.

The details of each alert are as follows.

No.	Name	Raising	Rectification	Support information
1	DEPTH UNSAFE	The water depth becomes the set value of the water depth alert or becomes shallower than that.	The water depth becomes deeper than the set value of the water depth alert	Sail toward depth area deeper than current position
2	LOST DEPTH	Sea bottom tracking is unavailable	Go to a sea area where depth can be measured	Confirm a depth on chart
3	NO PAPER	Out of paper	Refill a paper	Refill a paper(Refer5.2)
4	LOST PRINTER	Cannot communicate to printer	Replace a printer	Contact us or your agency
5	WEAK ECHO TX	Echo transmission level is low	Echo transmission level is normal	Contact us or your agency
6	WEAK ECHO RX	Echo receiving level is low	Echo receiving level is normal	Contact us or your agency
7	LOST PROCESSOR	Cannot communicate to processor unit	Restore communication to processor unit	Check network cable and connection
8	LOG MEMORY FAIL	Cannot access internal memory	Replace a processor unit	Contact us or your agency

Alert icon and status

The icon of the alert changes depending on the situation and status. JFE-400/700 Echo Sounder uses the icons in the table below.

No.	Name of alert icon	Functional outline	Alert icon
1	Active - unacknowledged alarm	A flashing red triangle. A symbol of loudspeaker in the middle of the triangle.	
2	Active - silenced alarm	A flashing red triangle. A symbol as in icon number 1 with a prominent diagonal line above it.	
3	Active - acknowledged alarm	A red triangle. An exclamation mark in the middle of the triangle.	
4	Rectified – unacknowledged alarm	A flashing red triangle. A tick mark in the middle of the triangle.	
5	Active - unacknowledged warning	A flashing yellowish orange circle. A symbol of loudspeaker in the middle of the circle.	
6	Active - silenced warning	A flashing yellowish orange circle. A symbol as in icon number 5 with a prominent diagonal line above it.	
7	Active - acknowledged warning	A yellowish orange circle. An exclamation mark in the middle of the circle.	
8	Active - responsibility transferred warning	A yellowish orange circle. An arrow pointing towards the right in the middle of the circle.	
9	Rectified - unacknowledged warning	A flashing yellowish orange circle. A tick mark in the middle of the circle.	
10	Caution	A yellow square. An exclamation mark in the middle of the square.	

* Silenced and Responsibility Transferred function are available when connected to the CAM system.

Alert Display

When an alert occurs, the alert message and icon are displayed at the top of the screen. After that, JFE-400/700 Echo Sounder can be operated by touching the screen as shown in the figure below.



● Alert Message (ex; LOST DEPTH)

24-03-24 05:04:20	←	Date and Time
10352 WARNING-V	←	Alert ID, Alert Priority
LOST DEPTH	←	Alert Name

● Alert Detail (ex; DEPTH UNSAFE)

24-03-24 05:04:15 ALARM-V	←	Date and Time, Alert Priority and Status
3031 DEPTH UNSAFE	←	Alert ID, Alert Name
FWD depth unsafe, avoid stranding	←	Detail Information

● Alert Status

On the Alert Detail screen, an acronym is added after alert priority to indicate alert status. The meaning of the acronym is as follows.

- A: Active Acknowledged
- V: Active Unacknowledged
- O: Responsibility Transferred
- S: Silence
- N: Normal
- U: Rectified Unacknowledged

● Visual display of alerts

Unacknowledged alarm and warning flash on Alert Messages and Alert Details Area. Caution is only lighting.
After acknowledged, alarm and warning are lighting.

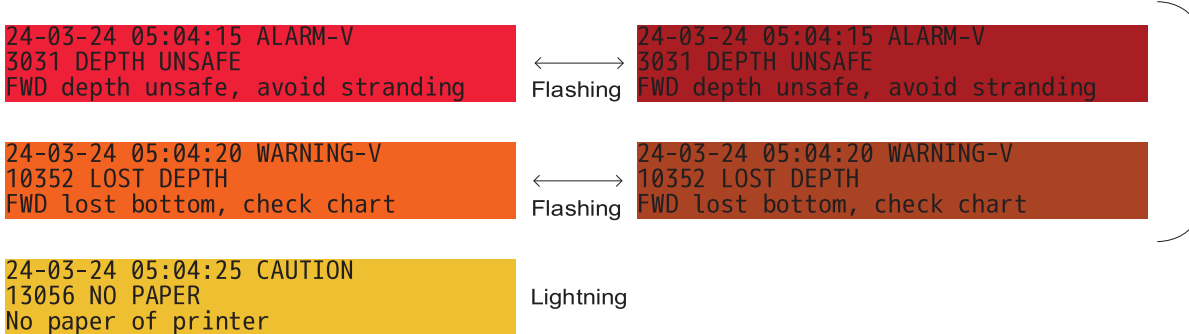



Alert List function

The Alert List function can also be selected from the main menu.

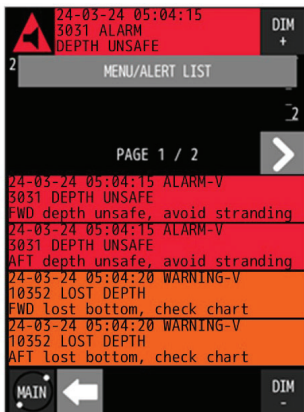
Touch  and , the Alert List screen will be displayed.







- Touch   to move to previous / next page.
- When  is touched, return to previous menu.

Alert History

JFE-400/700 Echo Sounder can display a list of alerts that have occurred in the past.

Touch  and , the Alert List screen will be displayed.



- Touch   to move to previous / next page .
- When  is touched, return to previous menu.
- When  is touched, print Alert History.
- When  is touched, stop printout.

* The Alert History can display up to 40 past alerts.

* The displayed content is the same as the content of the Alert Detail area.

Connecting with CAM system

Each alert can be displayed on not only own screen but also the CAM system by connecting CAM system. In addition, the following functions can be used by connecting to the CAM system.

- Alert silence from CAM

The alert sound ringing on JFE-400/700 Echo Sounder can be silenced by operating on the CAM system.

- Alert ACK from CAM

Applies to category –B alert in JFE-400/700 Echo Sounder.

Category- B alert generated on JFE-400/700 Echo Sounder can be acknowledged by operating on the CAM system.

- Responsibility Transfer to the CAM system

Applies to category –B alert in JFE-400/700 Echo Sounder.

JFE-400/700 Echo Sounder can transfer responsibility for Category B alerts at request of CAM.

Time variation of Alert

- Escalation

Applies to LOST DEPTH and LOST PROCESSOR alert.

When LOST DEPTH and LOST PROCESSOR alert are unacknowledged, they will re-generate an alert as same priority to user. This is for user attention when alert continues to be unacknowledged.

The escalation time is 5 minutes.

- Backup navigator call

Applies to DEPTH UNSAFE alert.

When JFE-400/700 Echo Sounder connects to BNWAS, Backup navigator call function can be used.

DEPTH UNSAFE is transferred to BNWAS. In this case, the alert is transferred as the 2nd stage alarm and finally, the 3rd stage alarm.

2nd stage: Back-up officer's and/or Master's location

3rd stage: Locations of further crew members.

(Blank page)

5. Maintenance & Check

WARNING



Do not open the equipment to inspect or repair internal circuits.
Inspection or repairs by anyone other than a specialized technician may result in fire, electrical shock, or malfunction.
If internal inspection or repair is necessary, contact our service center or agents.

5.1 Daily Maintenance

The life of the equipment depends on the execution situation of the daily maintenance and check. We would recommend regularly checking usually to always keep the best. As a result, the equipment can be prevented from breaking down beforehand.

Please execute the check shown in the table regularly.

5.2 Maintenance and check method

©When you check the equipment, turn off the power by all means.

No.	Item	Method
1	Cleaning	For the main unit, wash off dirt by lightly wiping it with a dried and soft cloth. Never use a plastic solvent such as thinner and benzine.
2	Loosening of parts	Check the screw and the nut for loosening, and tighten correctly.
3	Cable connection	Check the connections such as cables and the connectors between equipment, and ensure the connection.
4	Fuse	When the power supply fuse is blown, replace it after thoroughly investigating the cause. Use the fuse of the cylindrical glass (included in the spare parts).

5.3 Maintenance Function

Touch Panel Calibration

Refer to "Touch Panel Calibration" in 4.5 Initial Setting.

Displaying System No.

Refer to 4.7 Checking system version.

5.4 Replacing Printer Paper

⚠ CAUTION



Be careful not to cut your hands with the cutting edge of the paper cutter.

Name	Model type	Remarks
Printer paper	H-7ZPJD0384	TF50KS-E2D for build-in printer

ⓄAfter turning off the power supply of this equipment, exchange papers.

When the printer cover is opened while turning on, the alert of "NO PAPER" sounds.

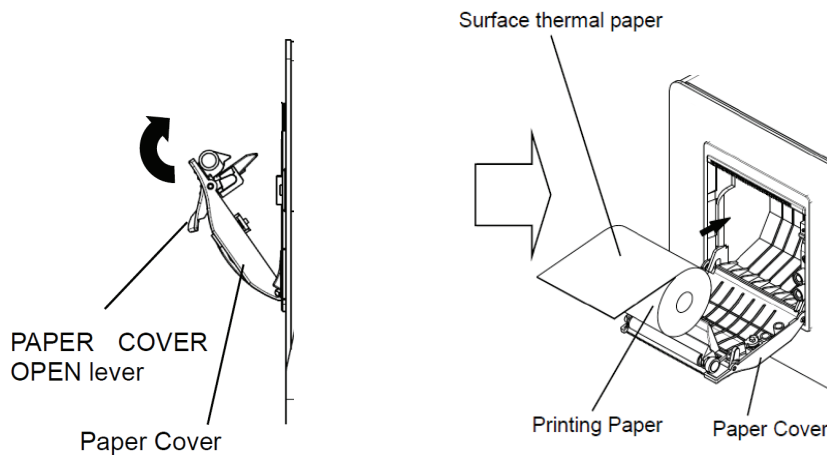

- ① Open the paper cover by pressing the paper cover opening button.
- ② Set the paper like the direction of figure.
- ③ Shut the cover after making the paper tip put out outside of the printer and pushing both ends of the upper paper cover.

*A red mark of a paper slip previous notice puts out from 1m remain when the remainder of the paper decreases.

5.5 Troubleshooting

The table below shows the principal symptom, the cause, and measurements. As a result, request the repair to our company or our agency when it is not possible to recover to normal operational condition.

Symptom	Cause	Measurements
The screen doesn't appear even if power switch is pressed.	The breaker of AC100-230V of the ship is "OFF".	Make the breaker of AC100-230V of the ship "ON".
	The main switch in processing unit is off	Check this switch and turn on.
	The Display processing unit is faulty.	Contact us or your distributor.
	Low brightness	brighten a screen
	The disconnection of the power supply AC inboard cable or the screw in the connecting terminal has loosened.	Repair the cable. Tighten the screw in the connecting terminal surely.
	The fuse is blown.	Replace the fuse.
The brightness is not changed	The display unit is faulty.	Contact us or your distributor.
	Software is not working properly	
No buzzer sound and key-tone is emitted.	The display unit is faulty.	Contact us or your distributor.
	Software is not working properly	
	Alert setting and key ack setting is off	Contact us or your distributor because setting menu is for service engineer.
The depth value is not displayed. Only the oscillation line is displayed in the image of a standard mode.	Actual sea bottom is deeper than the setting of range. (out of range)	Make the range setting AUTO. or, change the range setting manually and adjust it.
	The transducer cable has been disconnected.	Repair the cable.
The depth value is not displayed. The sea bottom echo is slightly recorded by the image of a standard mode.	The sensitivity setting is too weak.	Make the sensitivity setting AUTO. or, raise sensitivity.
	Sea bottom is mud (weak stratum).	Make the sensitivity setting AUTO. or, raise sensitivity.
	The oyster and the barnacle adhere to the transducer.	Remove the adhesion thing of the transducer at dry-dock.
	The cable disconnection of the transducer or the screw in the connecting terminal has loosened.	Check whether for be disconnected of the one side of the transducer. Tighten the screw in the connecting terminal surely.
The depth value is not correct.	A set value of the draft adjustment is not correct.	Set a correct value.
The depth value is not correct. In the image of a standard mode, the record mistaken in a middle layer as sea bottom appears.	The sensitivity setting is too strong.	It is recorded to garbage in water, dirt, and plankton's layers that sensitivity is too high, and recognizes sea bottom this. Make the sensitivity setting AUTO. Or, lower sensitivity.
There are a lot of records of the noise.	Noise generated from dynamo.	Check the dynamo.
	The main unit earth is imperfect.	Check the main unit earth.
	External interference noise.	The influence of the underwater sonic prospecting equipment of another ship has been received. This symptom is not a trouble of this equipment and originates in an external factor.
The echo displayed on the screen becomes all cyan.	Transmission is stopped.	Turn off the power of the display processing unit and restart it. When the problem persists, contact us or distributor.

5.6 Replacing Fuses

Exchange the fuse for the one of our specification. Exchange it after confirming the cause to which the fuse is blown. Moreover, turn off the main switch of the power supply CQD-2348 when you exchange fuses (Press sign side).

No.	Model type	Rating	Remarks
FH1	FGBO-A 250V 2A	250V 2A	For power supply in this equipment
FH2	MF51NR 250V 0.5 or equivalent	250V 0.5A	For power supply alert circuit in this equipment

5.7 Repair Parts

Parts name	Type	Code	Remarks
Main Unit	CDJ-2594	CDJ2594	
TX/RX Unit	CMN-869-20	CMN869-20	Single frequency for 200kHz
	CMN-869-50	CMN869-50	Single frequency for 50kHz
	CMN-869-22	CMN869-22	Dual frequencies for 200kHz/200kHz
	CMN-869-25	CMN869-25	Dual frequencies for 200kHz/50kHz
	CMN-869-55	CMN869-55	Dual frequencies for 50kHz/50kHz
Power Supply Unit	CBD-2016	CBD2016	
Interface unit	CQD-2348	CQD2348	
Power SW Control unit	CCK-1136	CCK1136	
LCD panel	CCN-555	CCN555	
Touch Panel Unit	CCK-1710	CCK1710	
Printer	H-7HPJD0003	H-7HPJD0003	

5.8 Regular replacement parts

Parts name	Type	Code	Replacement time	Remarks
LCD panel kit	CCN-555	CCN555	About 40,000hours	About 5 years in continuous use as the guideline

6. Consider Installation

- Do not install the JFE-700 where subject to the following conditions as such conditions may cause failures and reduce the life of the equipment.
 1. Where liable to be splashed with water.
 2. Where ventilation is poor.
- Do not coat the part of the transducer that outputs the ultrasonic waves (the rubber part of the tank on the ship's bottom) with the hull coating as this will deteriorate performance.

(Blank page)

7. After-sales Service

7.1 When Requesting Servicing

If you suspect a fault, stop using the equipment and contact JRC or its agent.

Servicing Under Warranty

When the fault develops while the equipment is being used as indicated in the Instruction Manual, the equipment will be repaired free of charge. However, if the fault occurs as the result of misuse, negligence, natural disaster, fire, or other acts of God, a charge will be made for its repair.

Servicing Out of Warranty

If the fault can be rectified by servicing the equipment, the repair will be made at your expense.

Details to be Submitted

- Name, type No., month and year of manufacture, and serial number;
- Nature of fault (in as much detail as possible);
- Contact details (your name, address and phone number, etc.)

7.2 Recommendations for Inspection and Maintenance

Depending on the conditions of usage, the performance may deteriorate due to the aging of components. In such conditions, please consult JRC or its agent for inspection and maintenance, as distinct from the daily care you normally give your equipment.

Note that such inspection and maintenance is subject to charge.

Please consult JRC or its agent for further details of any part of the after service conditions.

Contact: See at end of manual.

7.3 Warranty & After-sales Service

For further details of after-sale service, contact the JRC Offices.

■ Warranty Period

For one year after following installation. Warranty period is subject to change by contract.

■ Keeping period of maintenance parts

Keeping period of maintenance parts is ten years from the production is discontinued.

■ Repair within the Warranty Period

If any failure occurs in the product during its normal operation in accordance with the instruction manual, the dealer or JRC will repair free of charge. In case that any failure is caused due to misuse, faulty operation, negligence or force major such as natural disaster and fire, the product will be repaired with charges.

■ Repair after the Warranty Period

If any defective function of the product is recoverable by repair, the repair of it will be made at your own charge upon your request.

But if more than ten years has passed after the discontinuation of production and no maintenance parts, JRC cannot repair.

8. Disposal

8.1 Disposal of this equipment

When this equipment is to be disposed, please follow the guidelines of the local body governing the location at which the equipment is disposed of.

8.2 Chinese Version RoHS

有毒有害物质或元素的名称及含量

(Names & Content of toxic and hazardous substances or elements)

形式名(Type): JFE-700

名称(Name): Echo Sounder

部件名称 (Part name)	有毒有害物质或元素 (Toxic and Hazardous Substances and Elements)					
	铅 (Pb)	汞 (Hg)	镉 (Cd)	六价铬 (Cr6+)	多溴联苯 (PBB)	多溴二苯醚 (PBDE)
· 显示处理装置 (Display Processing Unit : NJA-710)	×	×	×	×	×	×
· 配套盒 (Matching Box:NQD-2597/2598)	×	×	×	×	×	×
· 船底装置 (Transducer Mounting:NKF-349/350)	×	×	×	×	×	×
外部设备 (Peripherals) · 选择 (Options) · 电线类 (Cables) · 手册 (Documennts)	×	×	×	×	×	×
<p>○：表示该有毒有害物质在该部件所有均质材料中的含量均在 SJ/T11306-2006 标准规定的限量要求以下。 (Indicates that this toxic, or hazardous substance contained in all of the homogeneous materials for this part is below the requirement in SJ/T11363-2006.)</p> <p>×：表示该有毒有害物质至少在该部件的某一均质材料中的含量超出 SJ/T11363-2006 标准规定的限量要求。 (Indicates that this toxic or hazardous substance contained in at least one of the homogeneous materials used for this part is above the limit requirement in SJ/T 11363-2006.)</p>						

(Blank page)

9. Specifications

Display	10.4 inch TFT LCD (1024 x 768 pixels)								
Frequency	200kHz / 50kHz								
Echo color	8 colors or 8 level monochrome								
Digital depth	3 digit (0.0m to 99.9m : 0.1m steps, 100m over : 1m steps)								
Range		5m	10m	20m	50m	100m	200m	500m	800m
Sounding capability (Note1)	200kHz	1.0m to 5m	1.0m to 10m	1.0m to 20m	1.5m to 50m	2.0m to 100m	3.0m to 200m	5.0m to 300m	7.0m to 300m
	50kHz	2.0m to 5m	2.0m to 10m	2.0m to 20m	3.0m to 50m	3.0m to 100m	4.0m to 200m	6.0m to 500m	8.0m to 800m
TX pulse repetition rate	pulse per minute	171 PPM	171 PPM	171 PPM	171 PPM	86 PPM	86 PPM	43 PPM	43 PPM
Accuracy	0.5m : 20m range, 5m : 200m range; or 2.5% of the indicated depth, whichever is greater								
Draft adjust	0m to 50m in 0.1m steps								
Display mode	Standard, History, Docking								
Time range of echo display	5, 10, 20, 30min								
Auto function	Gain, Range, Prevention interference with other ships								
Alert function	Depth, Power fail, System error								
Preview function	Max 48hour								
Transducers	200kHz : UT-200ND, 50kHz : UT-50MD								
Power supply	100-115/200-230VAC ± 15%, 50Hz/60Hz ± 5% 100VAC: Max120VA, 220VAC: Max175VA 24VDC (only use for power fail monitoring) Max1.4W								
Water proofing	Display processing unit : IP22 Connection Box : IP55								
Input nav. data	IEC61162-1NMEA0183 RMC, GGA, GLL, ZDA								
Input ACK signal	IEC61162-1NMEA0183 V1.5, V2.3 ACK V5.0 ACN								
Input signals	Power fail alert ACK: (Contact input: 12VDC 2.4mA, current control: 12VDC 1.2mA) Depth alert ACK, System alert ACK: (Contact input: 5VDC 5mA, current control: 12VDC 1.2mA)								
Output depth value data	IEC61162-1 (NMEA0183 V1.5)			DBS, DBT, DBK			every 1 second		
	IEC61162-1 (NMEA0183 V2.3, V5.0)			DPT			every 1 second		
Output alert data	IEC61162-1 (NMEA0183 V1.5, V2.3)			ALR			every 1 second		
	IEC61162-1 (NMEA0183 V5.0)			ALC, ALF, ARC, HBT			every 1 second		
Output system data	PJRCL			every 10 seconds					
	PJRCM			UTC			every 0 to 4 hours		
Output signals	Power fail alert, Depth alert, System alert: (Relay contact output: rated load 120VAC 10A, 30VDC 8A, NO/NC)								
LAN	Specification : IEC61162-450 Transmission speed : 10/100Mbps Data input/output : NMEA, IEC, JRC format IGMP snooping: IGMP v1, IGMPv2, IGMP v3								
Temperature	-15°C to +55°C / operating -25°C to +70°C / storage								
Humidity	less than 93%RH under +40°C condition (non-condensing)								

Note1: Sounding capability may vary in frequency, gain setting, bottom shape, sea state, vessel speed, etc.

(Blank page)

10. Appendix

10.1 Echo sample

Noise

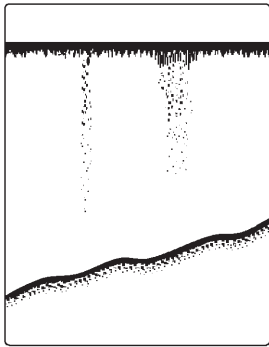

Bubble Noise

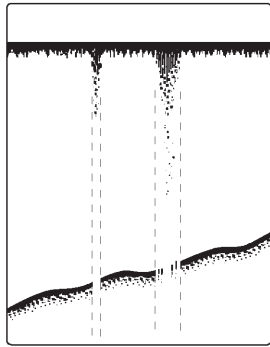

Bubble Interruption

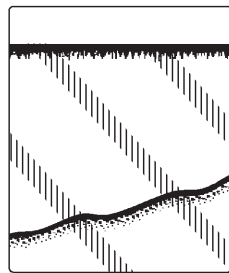
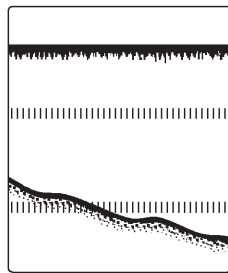
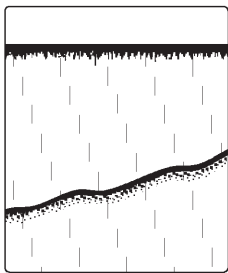

Interference Noise from other ship

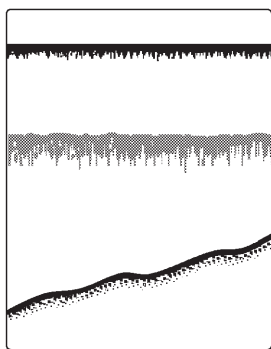

Plankton layer

Actual Pictures

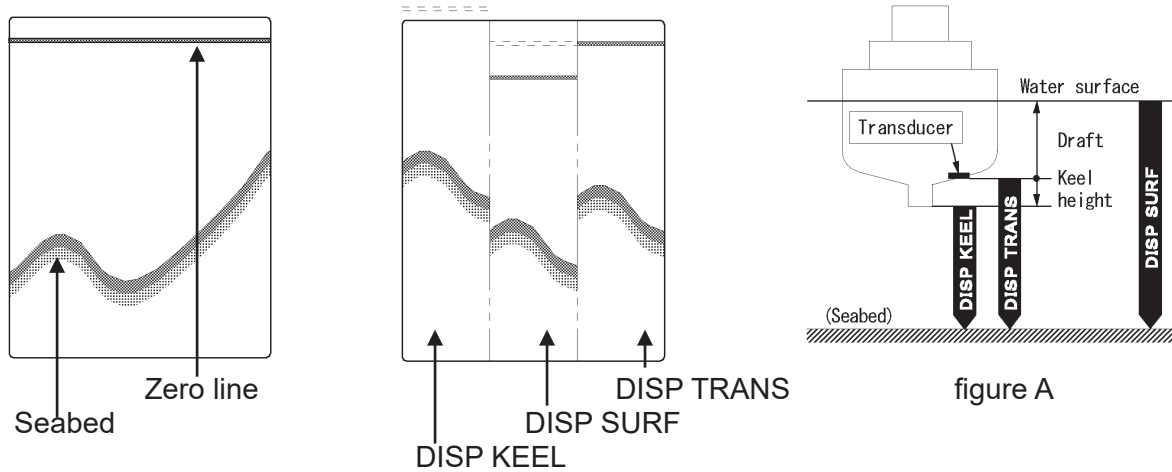

Seabed

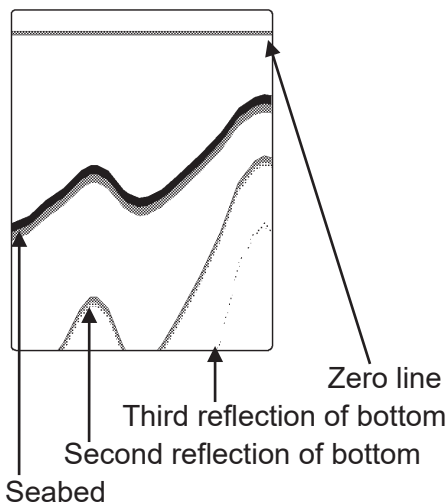

In case of a shallow seabed or when increasing the amplifier sensitivity, two seabed lines may be recorded.

This results from a multi-reflection of ultra-sonic wave between the seabed and hull bottom or surface of sea, in such manner: An emitted ultrasonic wave once reflected at the seabed returns toward the transducer or surface of sea but reflected at the hull bottom or surface of sea and again reflected at the seabed toward the transducer.

Such multiple recording of the seabed may appear due to change of bottom quality. A double or triple reflection may be sometimes recorded.

In any case, a first reflection recording from the zero line represents a real seabed return. A first, second and third reflection lines of seabed arrange with approximately equal spacing on the recording.

In addition, the shade of the reflection lines fades little by little away from the first line on the recording. From these conditions, they can be easily identified as a multi reflection.

Seabed Quality Change

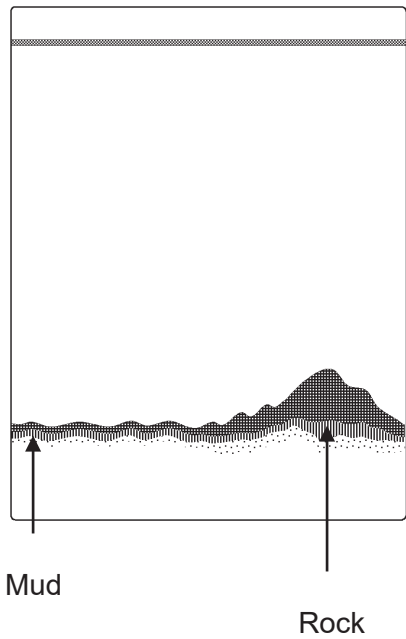

In case of a hard seabed composed of rocks etc., its return trails long, as shown in right chart. In case of a soft seabed made of mud, seaweed, etc., they poorly reflect an ultrasonic wave to result in thin recording of the seabed with short trail. The seabed quality can be more sufficiently identified with use of wider beam angle and longer pulse width. Usually lower frequency is used.

Abrupt-Sloped Seabed

Sidelobe

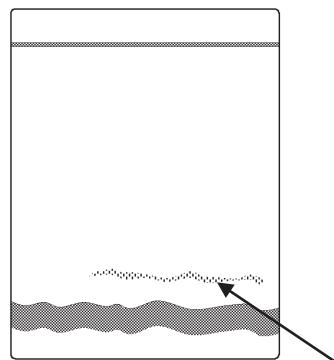
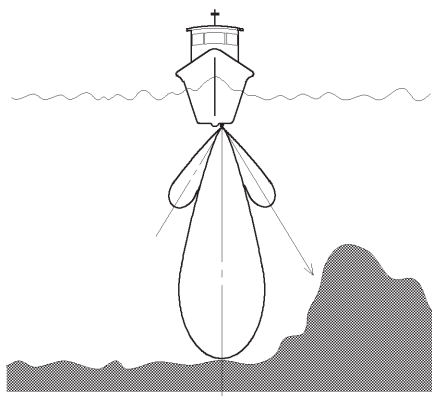

False echo

A dim echo may sometimes appear along an abrupt slope of seabed, as if it were floating above the slope, when recording.

In case of flat seabed, thin second return of seabed may sometimes appear, which is slightly below the actual seabed.

In either case, the dim or thin echoes are false and produced by side lobes of ultrasonic beam from the transducer. Any false echo is thinner than and parallel to a real echo.

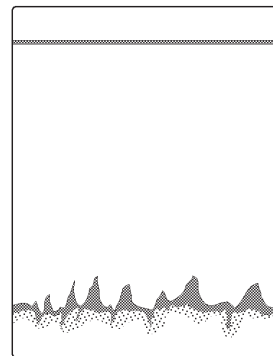
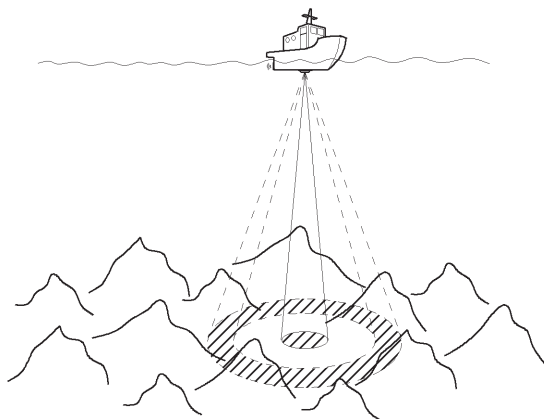
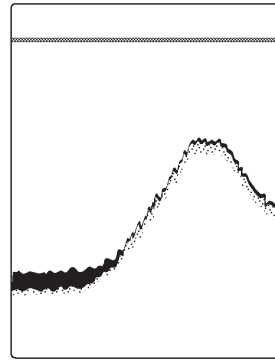
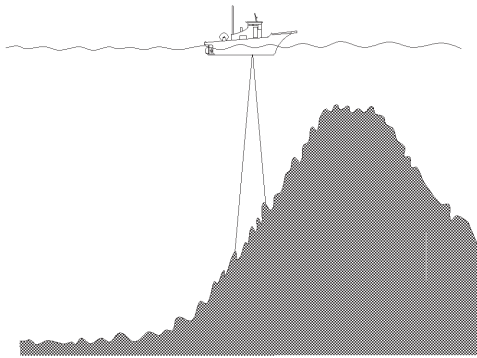

The echo of a seabed with abrupt slope is recorded as a lone difficult to see and less discriminative, since it tends to accompany with a false echo due to the side lobe and the inherent property of directivity.

In particular, a seabed with abrupt slope and heavily rugged surface provided an echo very difficult to display on the recording.

10.2 Data Format

1. List of Handling Sentence Data

No.	Sentence	Description	Message Type	Direction	Interface
1	DPT	Depth	SBM	Output	LAN & Serial
2	DBT	Depth below transducer	SBM	Output	LAN & Serial
3	DBK	Depth below keel	SBM	Output	LAN & Serial
4	DBS	Depth below surface	SBM	Output	LAN & Serial
5	PJRCU	Depth relative to transducer (2 frequencies)	-	Output	LAN & Serial
6	ALR	Set alarm state	-	Output	Serial
7	ALC	Cyclic alert list	MSM	Output	LAN & Serial
8	ALF	Alert sentence	MSM	Output	LAN & Serial
9	ARC	Alert command refused	SBM	Output	LAN & Serial
10	HBT	Heartbeat supervision sentence	SBM	Output/ Input	LAN & Serial
11	SRP	System function ID resolution protocol	SBM	Output	LAN
12	RMC	Recommended minimum specific GNSS data	SBM	Input	LAN & Serial
13	GGA	Global positioning system (GPS) fix data	SBM	Input	LAN & Serial
14	GLL	Geographic position – Latitude/longitude	SBM	Input	LAN & Serial
15	ZDA	Time and date	SBM	Input	LAN & Serial
16	ACN	Alert command	SBM	Input	LAN & Serial
17	ACK	Acknowledge alarm	-	Input	Serial

2. Output Data Format

1) DPT – Depth

\$--DPT,x.x,x.x,x.x*hh<CR><LF>

1 2 3

1: Water depth relative to the transducer, in meters

2: Offset from transducer, in meters 1) 2)

3: Maximum range scale in use

Note;

1) “positive” = distance from transducer to water line; “-“ = distance from transducer to keel.

2) For IEC applications, the offset should always be applied so as to provide depth relative to the keel.

2) DBT – Depth below transducer

\$--DBT, x.x, f, x.x, M, x.x, F*hh<CR><LF>

1 2 3

1: Water depth, feet

2: Water depth, meters

3: Water depth, fathoms

3) DBK – Depth below keel

\$--DBK, x.x, f, x.x, M, x.x, F*hh<CR><LF>

1 2 3

1: Water depth, feet

- 2: Water depth, meters
- 3: Water depth, fathoms

4) DBS – Depth below surface

\$--DBS, x.x, f, x.x, M, x.x, F*hh<CR><LF>
 1 2 3

- 1: Water depth, feet
- 2: Water depth, meters
- 3: Water depth, fathoms

5) PJRCU – Depth relative to transducer (2frequencies)

\$PJRCU,SD,x.x,x.x,x.x,x.x,xx,c-c*hh<CR><LF>
 1 2 3 4 5 6 7

- 1: Water depth relative to transducer, meters.
- 2: Offset from transducer, meters
- 3: Maximum range scale in use, meters
- 4: Reserved
- 5: Echo sounder channel number 1: reserved 2:50 kHz 3: 200 kHz
- 6: Transducer location FWD/MID/AFT
- 7: Checksum (result after each ASCII code of every character between "S" just after "\$" and "X" just before " * " is EXORed.)

6) ALR – Set alarm state(Legacy Alert sentece)

\$--ALR,hhmmss.ss,xxx,A,A,c--c*hh<CR><LF>
 1 2 3 4 5

- 1: Time of alarm condition change, UTC
- 2: Alarm condition (A = threshold exceeded, V = not exceeded)
- 3: Unique alarm number (identifier) at alarm source
- 4: Alarm's acknowledge state, A = acknowledged V = unacknowledged
- 5: Alarm's description text

7) ALC – Cyclic alert list

\$--ALC,xx,xx,xx,x.x,aaa,x.x,x.x,x.x,.....,aaa,x.x,x.x,x.x*hh <CR><LF>
 1 2 3 4 5 6 7 8 9 10

- 1: Total number of sentences for this message, 01 to 99 1
- 2: Sentence number, 01 to 99 1)
- 3: Sequential message identifier, 00 to 99 2)
- 4: Number of alert entries 3)
- 5: Manufacturer mnemonic code
- 6: Alert identifier
- 7: Alert instance
- 8: Revision counter
- 9: Additional Alert entries
- 10: Alert entry n 4)

Note;

- 1) The first field specifies the total number of sentences used for a message, minimum value 1.
- 1. The second field identifies the order of this sentence in the message, minimum value 1.

These cannot be null fields.

- 2) The sequential message identifier relates all sentences that belong to a group of multiple sentences (i.e. message). Multiple sentences with the same sequential message identifier, make up onemessage.
- 3) Contains the number of alert entries transported within this sentence.
- 4) Alert entry 0 – n: Each alert entry consists of four fields:
 - Manufacturer Identifier (see ALF Manufacturer Identifier)
 - Alert Identifier (see ALF Alert Identifier)
 - Alert instance (see ALF Alert instance)
 - Revision Counter (see ALF Revision Counter)

Each entry identifies a certain alert with a certain state. It is not allowed that an alert entry is split between two ALC sentences.

8) ALF – Alert sentence

\$--ALF,x,x,x,hhmmss.ss,a,a,a,aaa,x.x,x.x,x.x,x,c---c*hh <CR><LF>

1 2 3 4 5 6 7 8 9 10 11 12 13

- 1: Total number of ALF sentences for this message, 1 to 2 1)
- 2: Sentence number, 1 to 2 1)
- 3: Sequential message identifier, 0 to 9 2)
- 4: Time of last change 3)
- 5: Alert category, A, B or C 4)
- 6: Alert priority, E, A, W or C 5)
- 7: Alert state, A, S, N, O, U or V 6)
- 8: Manufacturer mnemonic code 7)
- 9: Alert identifier 8)
- 10: Alert instance, 1 to 999999 9)
- 11: Revision counter, 1 to 99 10)
- 12: Escalation counter, 0 to 9 11)
- 13: Alert text 12)

Note;

- 1) The first field specifies the total number of sentences used for a message, minimum value 1. The second field identifies the order of this sentence in the message, minimum value 1. These cannot be null fields. When the sentence number is 2, the following Alert category, Alert priority and Alert state can be null fields.
- 2) The sequential message identifier relates all sentences that belong to a group of multiple sentences (i.e. message). Multiple sentences with the same sequential message identifier, make up one message.
- 3) Time should represent the last time the data within the alert message has changed. For example changing the alert text by in-/decrementing a contained counter or count down should cause a revision of alert message and a new time. Time is an optional field. The time-field is additional information about when this happened and not used for decision making. There is no mandatory requirement for time synchronization between the equipment. It should be either a null field (if not used) or UTC (if used). Sender is allowed to use all alternatives defined in Table 5 Field type summary. Receiver is allowed to ignore content of this field. If the receiver does not ignore this field it should support all alternatives defined in Table 5 Field type summary.
- 4) The alert category is in compliance with the category definition as described in INS Performance Standard (IMO MSC.252(83)) and Bridge Alert Management Performance

Standard (IMO MSC.302(87)):

- A, Category A: Alerts where information at operator unit directly assigned to the function generating the alert is necessary, as decision support for the evaluation of the alert-related condition, e.g. graphical information of danger of collision or graphical information of danger of grounding.
 - B, Category B: Alerts where no additional information for decision support is necessary besides the information which can be presented using alert source and alert description text.
 - C, Category C: Alerts that cannot be acknowledged on the bridge but for which information is required about the status and treatment of the alerts, e.g., certain alerts from the engine.
- 5) Alert priority: Emergency Alarm: E, for use with Bridge alert management
Alarm: A
Warning: W
Caution: C
- 6) The alert state transition is defined in IEC 61924-2:2012, Annex J
active – unacknowledged: V
active – silenced: S
active – acknowledged or active: A
active – responsibility transferred: O
rectified – unacknowledged: U
normal: N
- 7) Used for proprietary alerts defined by the manufacturer. For standardized alerts this should be a null field.
- 8) The alert identifier is unique within a single alert source. The alert identifier is a variable length integer field of maximum a 7-digit integer. It identifies the type of the alert, e.g. a “lost target” alert. Standardized alerts use unique alert identifiers described in equipment standards. Number range 10000-9999999 is reserved for proprietary alerts. Alert Identifier examples: “001”, “2456789”, “245”
- 9) The alert instance identifies the current instance of an alert to distinguish alerts of the same type (Alert identifier) and from the same source (e.g. dangerous target). Alert instance is maximum a 6-digit integer from 1 to 999999, the number ‘0’ indicates that this sentence is intended for all alert instances. Except for number ‘0’, the number of alert instance can be freely defined by the manufacturer as long as it is unique for one type of alert (alert identifier). It is not permitted to modify the alert instance within a life cycle of a distributed alert (from ‘active and unacknowledged’ state until ‘normal’ state is reached). It can be also a null field, when there is only one alert of that type.
- 10) The revision counter is the main method to follow up-to-date status. Revision counter is also unique for each instance of alert. Revision counter starts with 1 and the step for increment is 1. The count resets to 1 after 99 is used. Revision counter increments on each change of content of any field of the alert.
- 11) The escalation counter is presenting the number of alert escalations after time expiration during the state active-unacknowledged. The escalation counter starts with 0 and the step for increment is 1. The count resets to 1 after 9 is used. The alert escalation can be the escalation from warning into warning (activation of audible signal only), the escalation from warning to alarm or the escalation from alarm to alarm with activation of backup navigator alarm.

12) This field is used for Alert title which is mandatory and for additional alert description which is optional.

- The first ALF sentence transmits the Alert title. Alert title is maximum 16 characters short form of the alert text.
- The optional second ALF sentence transmits the additional alert description. Additional alert description is the long description of the alert. The additional alert description contains more information for decision making (i.e. alert description text).
- The second ALF sentence uses null fields for Time of last change, Alert category, Alert priority, and Alert state to allow longer text. The actual number of valid characters should be such that the total number of characters in a sentence does not exceed the “82”-character limit.
- Some equipment standards specify alert text longer than 16 characters (for example the AIS standard has defined some alerts to be coded with ALR sentence and with text longer than 16 characters). In such cases the first ALF sentence is used for the first 16 characters of the alert text as alert title and the second ALF sentence to carry the full alert text.

9) ARC – Alert command refused

\$--ARC,hhmmss.ss,aaa,x.x,x.x,c*hh <CR><LF>

1 2 3 4 5

- 1: Time 1)
- 2: Manufacturer mnemonic code 2)
- 3: Alert identifier 3)
- 4: Alert instance, 1 to 999999 4)
- 5: Refused alert command, A, Q, O or S 5)

Note;

- 1) Release time of the Alert Command Refused. (e.g. for VDR purposes), optional, can be a null field. Sender is allowed to use all alternatives defined in Table 5 Field type summary. Receiver is allowed to ignore content of this field. If receiver does not ignore this field it should support all alternatives defined in Table 5 Field type summary.
- 2) Used for proprietary alerts defined by the manufacturer. For standardized alerts this should be a null field.
- 3) The alert identifier is unique within a single alert source. The alert identifier is a variable length Integer field of maximum a 7-digit integer. It identifies the type of the alert, e.g. a “lost target” alert. Standardized alerts use unique alert identifiers described in equipment standards. Number range 10000-9999999 is reserved for proprietary alerts. Alert Identifier examples: “001”, “2456789”, “245”
- 4) The alert instance identifies the current instance of an alert to distinguish alerts of the same type (Alert identifier) and from the same source (e.g. dangerous target). Alert instance is maximum a 6-digit integer from 1 to 999999. The number of alert instance can be freely defined by the manufacturer as long as it is unique for one type of alert (alert identifier). It is not permitted to modify the alert instance within a life cycle of a distributed alert (from ‘active and unacknowledged’ state until ‘normal’ state is reached). It can be also a null field, when there is only one alert of that type.
- 5) Refused Alert Command: Indicates refused “Alert command” of corresponding ACN sentence. This should not be a null field.
acknowledge: A
request / repeat information: Q

responsibility transfer: O
silence: S

10) HBT – Heartbeat supervision sentence

`$--HBT,x.x,A,x*hh<CR><LF>`

1 2 3

- 1: Configured repeat interval 1)
- 2: Equipment status 2)
- 3: Sequential sentence identifier 3)

Note;

- 1) Configured autonomous repeat interval in seconds. This field should be set to NULL in response to a query if the query response feature is supported.
- 2) Equipment in normal operation A = yes, V = no
This field can be used to indicate the current equipment status. This could be the result of an built-in integrity testing function.
- 3) The sequential sentence identifier provides a message identification number from 0 to 9 that is sequentially assigned and is incremented for each new sentence. The count resets to 0 after 9 is used.

11) SRP-System function ID resolution protocol

`¥s:ccxxx*hh¥$--SRP,x,hhhhhhhhhhhh,c--c*hh<CR><LF>`

1 2 3 4

- 1: SFI of the transmitter 1)
- 2: Instance number of redundant alternative 2)
- 3: MAC address 3)
- 4: IP address 4)

Note;

- 1) Reported SFI of the transmitter
- 2) Instance number for interface redundancy (i.e. number of physical port for identical SFI), null if interface redundancy not in use. The instance numbers shall be ordinal with no skipping (1, 2, 3,...).
- 3) Reported MAC address used by SFI, 48bit hexadecimal number, for example 32613C4EB605
- 4) Reported IP address used by SFI as text string, for example 239.192.0.1

3 Input Data Format

1) HBT – Heartbeat supervision sentence

`$--HBT,x.x,A,x*hh<CR><LF>`

1 2 3

- 1: Configured repeat interval 1)
- 2: Equipment status 2)
- 3: Sequential sentence identifier 3)

Note;

- 1) Configured autonomous repeat interval in seconds. This field should be set to NULL in response to a query if the query response feature is supported.

- 2) Equipment in normal operation A = yes, V = no
This field can be used to indicate the current equipment status. This could be the result of an built-in integrity testing function.
- 3) The sequential sentence identifier provides a message identification number from 0 to 9 that is sequentially assigned and is incremented for each new sentence. The count resets to 0 after 9 is used.

2) RMC – Recommended minimum specific GNSS data

\$--RMC,hhmmss.ss,A,llll.ll,a,yyyyy.yy,a,x.x,x.x,xxxxxx,x.x,a,a,a*hh<CR><LF>

1 2 3 4 5 6 7 8 9 10

- 1: UTC of position fix
- 2: Status 3) A = data valid V = navigation receiver warning
- 3: Latitude, N/S
- 4: Longitude, E/W
- 5: Speed over ground, knots
- 6: Course over ground, degrees true
- 7: Date: dd/mm/yy
- 8: Magnetic variation,degrees, E/W 1)
- 9: Mode indicator 2) 3)
- 10: Navigational status 4)

Note;

- 1) E = Easterly variation subtracts from True course
W = Westerly variation adds to True course
- 2) Positioning system mode Indicator:
A = Autonomous. Satellite system used in non-differential mode in position fix;
D = Differential. Satellite system used in differential mode in position fix;
E = Estimated (dead reckoning) mode;
F = Float RTK. Satellite system used in real time kinematic mode with floating integers;
M = Manual input mode;
N = No fix. Satellite system not used in position fix, or fix not valid;
P = Precise. Satellite system used in precision mode. Precision mode is defined as: no deliberate degradation (such as selective availability) and higher resolution code (P-code) is used to compute position fix. P is also used for satellite system used in multi-frequency, SBAS or Precise Point Positioning (PPP) mode;
R = Real time kinematic. Satellite system used in RTK mode with fixed integers;
S = Simulator mode.
- 3) The positioning system mode indicator field supplements the positioning system status field. The status field should be set to V = Invalid for all values of the mode indicator except for A= Autonomous, D = Differential, F = Float RTK, P = Precise and R = Real time kinematic. The positioning system mode indicator and status fields should not be null fields.
- 4) The navigational status indicator is according to IEC 61108 requirements on 'Navigational (or Failure) warnings and status indications'. This field should not be a NULL field and the character should take one of the following values:
S = Safe when the estimated positioning accuracy (95 % confidence) is within the selected accuracy level corresponding to the actual navigation mode, and/or integrity is available and within the requirements for the actual navigation mode, and/or a new valid position has been calculated within 1 s for a conventional craft and 0,5 s for a

high speed craft.

C = Caution when integrity is not available.

U = Unsafe when the estimated positioning accuracy (95 % confidence) is less than the selected accuracy level corresponding to the actual navigation mode, and/or integrity is available but exceeds the requirements for the actual navigation mode, and/or a new valid position has not been calculated within 1 s for a conventional craft and 0,5 s for a high speed craft. V = Navigational status not valid, equipment is not providing navigational status indication.

3) GGA – Global positioning system (GPS) fix data

\$--GGA, hhmmss.ss, llll.ll, a, yyyy.yy, a, x, xx, x.x, x.x, M, x.x, M, x.x, xxxx*hh<CR><LF>
 1 2 3 4 5 6 7 8 9 10 11 12

- 1: UTC of position
- 2: Latitude N/S
- 3: Longitude E/W
- 4: GPS quality indicator 1)
- 5: Number of satellites in use, 00-12, maybe different from the number in view
- 6: Horizontal dilution of precision
- 7: Antenna altitude above/below mean sea level (geoid)
- 8: Units of antenna altitude, m
- 9: Geoidal separation 3)
- 10: Units of geoidal separation, m
- 11: Age of differential GPS data 2)
- 12: Differential reference station ID, 0000-1023

Note;

- 1) All GPS quality indicators in headings 1 through 8 are considered “valid”. The heading “0” is the only “invalid” indicator. The GPS quality indicator field should not be a null field.
 - 0 = fix not available or invalid
 - 1 = GPS SPS mode
 - 2 = differential GPS, SPS mode
 - 8 = Simulator mode
- 2) Time in seconds since last SC104 type 1 or 9 update, null field when DGPS is not used.
- 3) Geoidal separation: the difference between the WGS-84 earth ellipsoid surface and mean sea level (geoid) surface, “ – “ = mean sea level surface below the WGS-84 ellipsoid surface.

4) GLL – Geographic position – Latitude/longitude

\$--GLL, llll.ll, a, yyyy.yy, a, hhmmss.ss, A, a *hh<CR><LF>
 1 2 3 4 5 6 7

- 1: Latitude, N/S
- 2: Latitude, N/S
- 3: Longitude, E/W
- 4: Longitude, E/W
- 5: UTC of position
- 6: Status 2) A=data valid V=data invalid
- 7: Mode indicator 1) 2)

Note;

1) Positioning system mode indicator:

D = Differential

S = Simulator

N = Data not valid

2) The mode indicator field supplements the status field (field 6). The status field should be set to V = invalid for all values of operating mode except for A = Autonomous and D = Differential. The positioning system mode indicator and status fields should not be null fields.

5) ZDA – Time and date

\$--ZDA, hhmmss.ss, xx, xx, xxxx, xx, xx*hh<CR><LF>
 1 2 3 4 5 6

1: UTC

2: Day, 01 to 31 (UTC)

3: Month, 01 to 12 (UTC)

4: Year (UTC)

5: Local zone hours 1), 00 h to ±13 h

6: Local zone minutes 1), 00 to +59

Note;

1) Local time zone is the magnitude of hours plus the magnitude of minutes added, with the sign of local zone hours, to local time to obtain UTC. Local zone is generally negative for East longitudes with local exceptions near the international date line.

Example: At Chatham Is. (New Zealand) at 1230 (noon) local time on June 10, 1995:

\$GPZDA,234500,09,06,1995,-12,45*6C<CR><LF>

In the Cook Islands at 1500 local time on June 10, 1995:

\$GPZDA,013000,11,06,1995,10,30*4A<CR><LF>

6) ACN – Alert command

\$--ACN, hhmmss.ss, aaa, x.x, x.x, c, a*hh <CR><LF>
 1 2 3 4 5 6

1: Time 1)

2: Manufacturer mnemonic code 2)

3: Alert Identifier 3)

4: Alert Instance, 1 to 999999 4)

5: Alert command, A, Q, O or S 5)

6: Sentence status flag 6)

Note;

- 1) Release time of the alert command. (e.g. for VDR purposes), optional can be a null field. Sender is allowed to use all alternatives defined in Table 5 Field type summary. Receiver is allowed to ignore content of this field. If receiver does not ignore this field it should support all alternatives defined in Table 5 Field type summary.
- 2) Used for proprietary alerts defined by the manufacturer. For standardized alerts this should be a null field.
- 3) The alert identifier is unique within a single alert source. The alert identifier is a variable length integer field of maximum 7-digit integer. It identifies the type of the alert, e.g. a "lost target" alert. Standardized alerts use unique alert identifiers

described in equipment standards. Number range 10000-99999999 is reserved for proprietary alerts and number '0' is reserved for a command request to all alerts (e.g. alert command Q requests transmission of all alert states). Alert Identifier examples: "001", "2456789", "245"

- 4) The alert instance identifies the current instance of an alert to distinguish alerts of the same type (Alert identifier) and from the same source (e.g. dangerous target). Alert instance is maximum a 6-digit integer from 1 to 999999, the number '0' indicates that the command is intended for all alert instances. Except for number '0', the number of alert instance can be freely defined by the manufacturer as long as it is unique for one type of alert (alert identifier). It is not permitted to modify the alert instance within a life cycle of a distributed alert (from 'active and unacknowledged' state until 'normal' state is reached). It can be also a null field, when there is only one alert of that type.
- 5) This should not be a null field
acknowledge: A
request / repeat information: Q
responsibility transfer: O
silence: S
- 6) This field should be "C" and should not be a null field. This field indicates a command. A sentence without "C" is not a command.

7) ACK – Acknowledge alarm(Legacy Alert sentence)

\$--ACK,xxx*hh<CR><LF>

1

1: Unique alarm number (identifier) at alarm source.

アスベストは使用していません
Not use the asbestos

For further information, contact:

JRC *Japan Radio Co., Ltd.*

Since 1915

URL Head office : <http://www.jrc.co.jp/eng/>

Marine Service Department

1-7-32 Tatsumi, Koto-ku, Tokyo 135-0053, Japan

e-mail : tmsc@jrc.co.jp

One-call : +81-50-3786-9201

ISO 9001, ISO 14001 Certified